

## SIRIUS HRI

Hochdruck-Entladungslampen mit Reflektor



### Anwendungsgebiete

- Konzertbeleuchtung
- Club und Disco
- Bühne und Theater
- Studio, TV und Film
- Architecture & Architainment

### Produktfamilien-Vorteile

- Leichte und kompakte Reflektorlampen
- Perfekt geeignet für kleine und leichte Moving Heads
- Optimiertes Brennerdesign ermöglicht jede Brennstellung
- Hohe Leuchtdichte durch sehr kurzen Lichtbogen und hohen Druck
- Helles Licht für brillante Lichteffekte
- Lange Lebensdauer
- Einfacher Lampenwechsel
- Gleichmäßige Lichtausbeute über die gesamte Lebensdauer

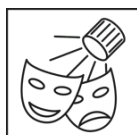

## Familiendatenblatt

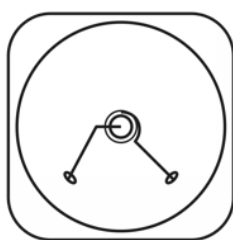
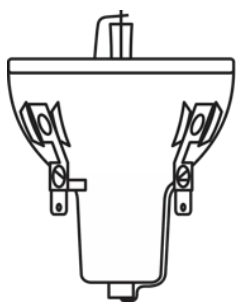

666507\_SIRIUS HRI 100W

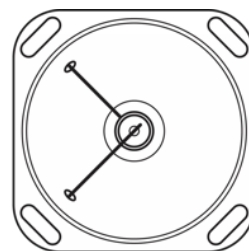
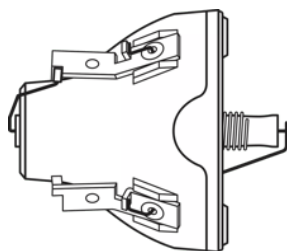

350611\_SIRIUS HRI 132W

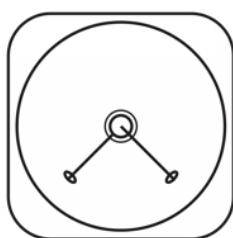
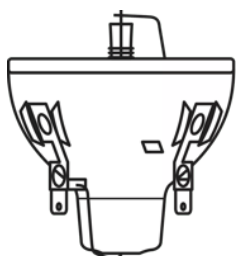

488735\_SIRIUS HRI 132W

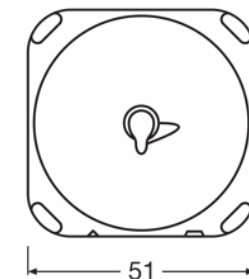
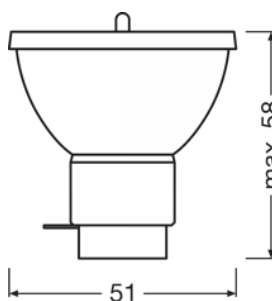

SIRIUS HRI 251W

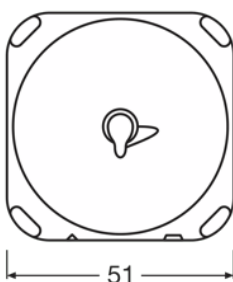
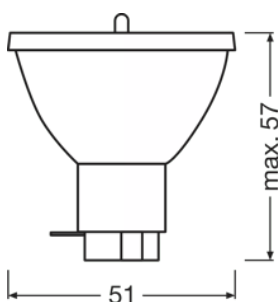

SIRIUS HRI 295 W

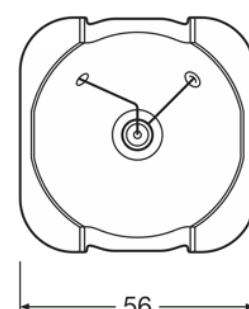
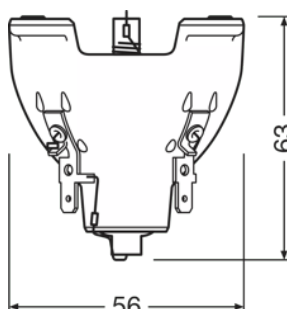

501950\_SIRIUS HRI 330W

# Familiendatenblatt

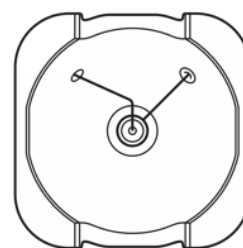
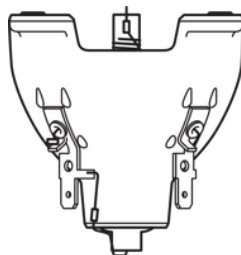
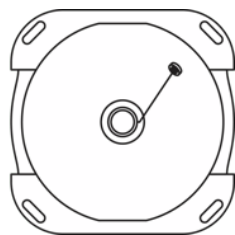
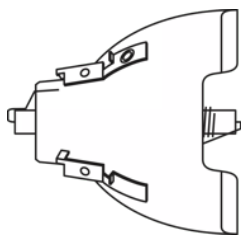

333382\_SIRIUS HRI 330W

501965\_SIRIUS HRI 330W

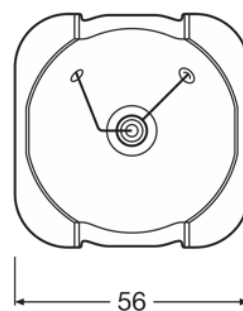
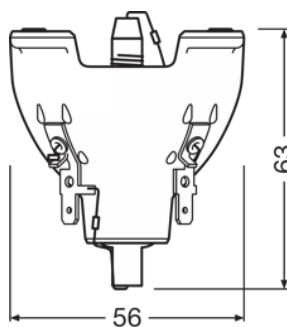
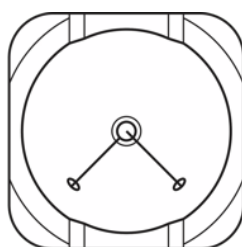
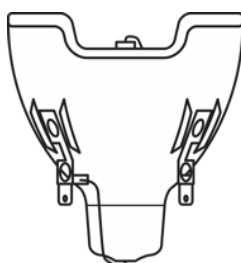

488771\_SIRIUS HRI 330W X8

501949\_Sirius HRI 330W XL

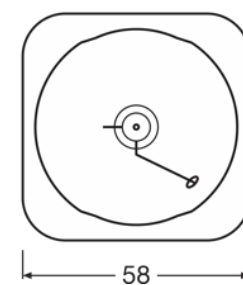
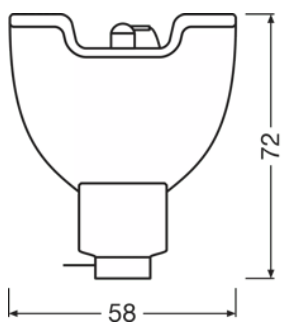
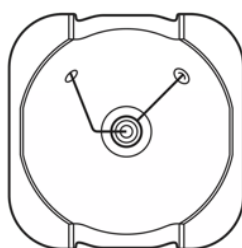
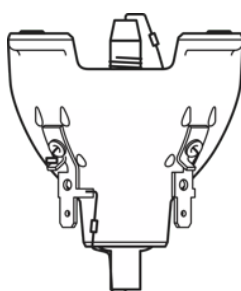

501963\_Sirius HRI 330W XL

SIRIUS HRI 371W

# Familiendatenblatt

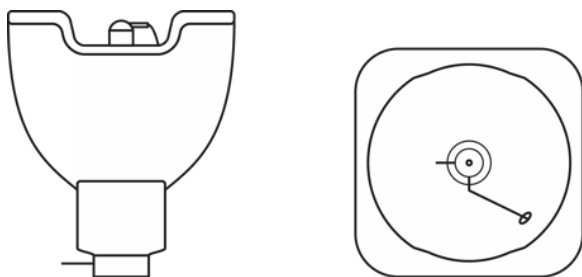

SIRIUS HRI 371W

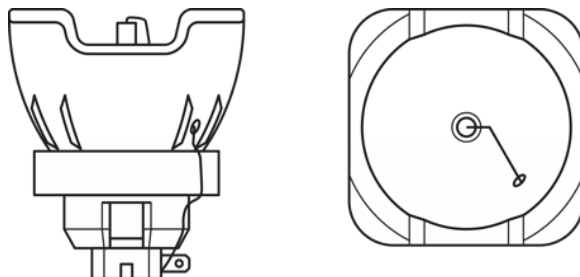

668858\_SIRIUS HRI 440W

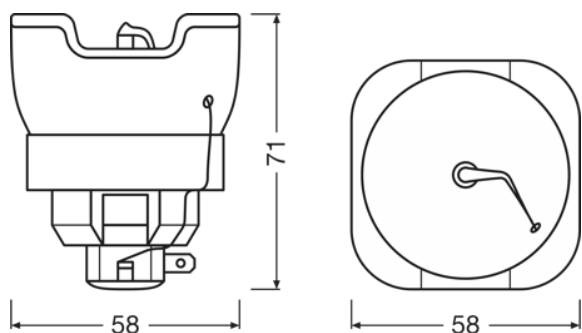

SIRIUS HRI 580 F

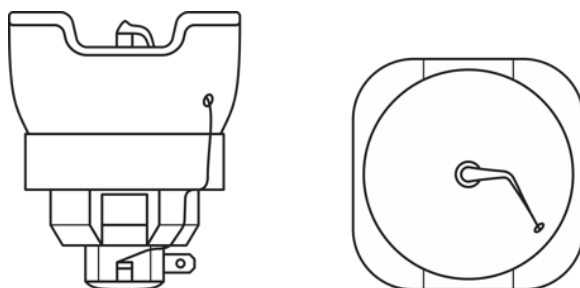

SIRIUS HRI 580 F

## Technische Daten

Produkt-Bezeichnung	Elektrische Daten		Photometrische Daten				Lichttechnische Daten
	Nennleistung	Nennstrom	Nennlichtstrom	Farbtemperatur	Farbwiedergabeindex Ra	Maximale Farbtemperatur	Auflagemaß
SIRIUS HRI 100 W	100.00 W	18 A	3680 lm	9000 K	60	9300 K	30.0 mm
SIRIUS HRI 132 W SC	132.00 W	18 A	5150 lm	9200 K	60	9200 K	37.7 mm
SIRIUS HRI 140 W RO	140.00 W	19 A	5400 lm	9200 K	60	9200 K	37.7 mm
SIRIUS HRI 190 W+	190.00 W	27 A	8100 lm	8200 K	73		
SIRIUS HRI 230 W	230.00 W	33 A	9500 lm	8000 K	75	8000 K	34,5 mm
SIRIUS HRI 231 W	231.00 W	33 A	10800 lm	8000 K	75		
SIRIUS HRI 251 W	250.00 W	35 A	12000 lm	8000 K	77		
SIRIUS HRI 260 W PRO	260.00 W	37 A	13500 lm	7800 K	79		
SIRIUS HRI 280 W	280.00 W	4 A	11500 lm	7800 K	78	7800 K	35.5 mm
SIRIUS HRI 280 W RO	280.00 W	4 A	11500 lm	7800 K	78		
SIRIUS HRI 281 W	281.00 W	4 A	13000 lm	7800 K	78		
SIRIUS HRI 295 W	295.00 W	4.1 A	11300 lm	7800 K	78		
SIRIUS HRI 310 W	310.00 W	45 A	15000 lm	8000 K	84		
SIRIUS HRI 310 W RO	310.00 W	48 A	13000 lm	8500 K	78		
SIRIUS HRI 310 W PRO	310.00 W	5 A	15500 lm	7650 K	85		
SIRIUS HRI 311 W	310.00 W	33 A	14500 lm	8000 K	75		
SIRIUS HRI 330 W	330.00 W	5 A	18000 lm	7400 K	86	7400 K	31.0 mm
SIRIUS HRI 330 W X8	330.00 W	44 A	18000 lm	8000 K	85		
SIRIUS HRI 330 W XL	330.00 W	5 A	16500 lm	7250 K	71		
SIRIUS HRI 371 W	371.00 W	5 A	18300 lm	7650 K	85		
SIRIUS HRI 371 W S	371.00 W	5 A	19800 lm	7650 K	85		
SIRIUS HRI 371 W +	370.00 W	5 A	18300 lm	7650 K	85		
HRI 371 W S +	370.00 W	5 A	19800 lm	7650 K	85		
SIRIUS HRI 381 W S	380.00 W	5 A	20000 lm	7700 K	85		
SIRIUS HRI 380 W Pro	380.00 W	5 A	20000 lm	7700 K	85		
SIRIUS HRI 380 W S PRO	380.00 W	5 A	20000 lm	7700 K	85		
SIRIUS HRI 382 W	382.00 W	54 A	21000 lm	7650 K	85		
SIRIUS HRI 382 W S	380.00 W	54 A	20000 lm	7650 K	85		
SIRIUS HRI 420 W	420.00 W	5 A	22000 lm	7700 K	85		
SIRIUS HRI 420 W S	420.00 W	5 A	21000 lm	7700 K	85		
SIRIUS HRI 440 W	440.00 W	53 A	20000 lm	7000 K	80	7000 K	41.0 mm
SIRIUS HRI 440 W +	440.00 W	53 A	22800 lm	7000 K	80		
SIRIUS HRI 440 W H	440.00 W	53 A	18000 lm	7000 K	75		
SIRIUS HRI 440 W S	440.00 W	44 A	22800 lm	7000 K	80		
SIRIUS HRI 440 W X	440.00 W	53 A	22800 lm	7000 K	80		
SIRIUS HRI 461 W	461.00 W	53 A	24000 lm	7500 K	80		
SIRIUS HRI 461 W S	461.00 W	53 A	24000 lm	7500 K	80		

## Familiendatenblatt

Produkt-Bezeichnung	Elektrische Daten		Photometrische Daten			Lichttechnische Daten	
	Nennleistung	Nennstrom	Nennlichtstrom	Farbtemperatur	Farbwiedergabeindex Ra	Maximale Farbtemperatur	Auflagemaß
SIRIUS HRI 462 W	295.00 W	6.20 A	24000 lm	7900 K	85		
SIRIUS HRI 470 W	470.00 W	53 A	20500 lm	7000 K	80		
SIRIUS HRI 470 W S	470.00 W	53 A	21500 lm	7000 K	80		
SIRIUS HRI 470 W RO	470.00 W	5.3 A	19500 lm	7500 K	80		
SIRIUS HRI 470 W XL	470.00 W	53 A	24000 lm	7500 K	80		
SIRIUS HRI 471 W SN	471.00 W	53 A	20000 lm	7500 K	80		
SIRIUS HRI 550 W	550.00 W	6.1 A	28000 lm	7000 K	75		
SIRIUS HRI 550 W XL	550.00 W	6.1 A	28000 lm	7500 K	75		
HRI 580 W F	580.00 W	61 A	29500 lm	7000 K	75		

Produkt-Bezeichnung	Apertur-Fenster max.	Abmessungen & Gewicht		Lebensdauer	Einsatzmöglichkeiten	
		Durchmesser	Länge	Lebensdauer	Brennstellung	Kühlung
SIRIUS HRI 100 W	5x3.8 mm	45.0 mm	53.0 mm	6000 h	Beliebig	Forciert
SIRIUS HRI 132 W SC	5x3.8 mm	46.0 mm	max. 44 mm	6000 h	Beliebig	Forciert
SIRIUS HRI 140 W RO	5x3.8 mm	46.0 mm	max. 44 mm	6000 h	Beliebig	Forciert
SIRIUS HRI 190 W+		51.0 mm	54.5 mm	3000 h		
SIRIUS HRI 230 W	5x3.8 mm	51.0 mm	54.5 mm	2500 h	Beliebig	Forciert
SIRIUS HRI 231 W		51.0 mm	50.0 mm	2000 h	Beliebig	
SIRIUS HRI 251 W		51.0 mm	61.0 mm	3000 h		
SIRIUS HRI 260 W PRO		51.0 mm	50.0 mm	6000 h		
SIRIUS HRI 280 W	5x3.8 mm	51.0 mm	54.5 mm	2000 h	Beliebig	Forciert
SIRIUS HRI 280 W RO		51.0 mm	54.5 mm	2000 h	Beliebig	
SIRIUS HRI 281 W		51.0 mm	50.0 mm	2000 h	Beliebig	
SIRIUS HRI 295 W		51.0 mm	53.5 mm	2500 h		
SIRIUS HRI 310 W		51.0 mm	53.5 mm	2500 h		
SIRIUS HRI 310 W RO		60.0 mm	67.0 mm	4000 h	Beliebig	
SIRIUS HRI 310 W PRO		58.0 mm	72.0 mm	6000 h		
SIRIUS HRI 311 W		51.0 mm	50.0 mm	1500 h		
SIRIUS HRI 330 W	8.0 mm	56.0 mm	63.0 mm	1500 h	Beliebig	Forciert
SIRIUS HRI 330 W X8		58.0 mm	66.0 mm	1500 h	Beliebig	
SIRIUS HRI 330 W XL		56.0 mm	63.0 mm	1500 h	Beliebig	
SIRIUS HRI 371 W		58.0 mm	72.0 mm	1500 h	Beliebig	
SIRIUS HRI 371 W S		58.0 mm	72.0 mm	1500 h	Beliebig	
SIRIUS HRI 371 W +		58.0 mm	72.0 mm	3000 h		
HRI 371 W S +		58.0 mm	72.0 mm	3000 h		
SIRIUS HRI 381 W S		58.0 mm	72.0 mm	2500 h		
SIRIUS HRI 380 W Pro		58.0 mm	72.0 mm	2500 h		
SIRIUS HRI 380 W S PRO		58.0 mm	72.0 mm	6000 h		
SIRIUS HRI 382 W		58.0 mm	72.0 mm	2500 h		

## Familiendatenblatt

Produkt-Bezeichnung	Apertur-Fenster max.	Abmessungen & Gewicht		Lebensdauer	Einsatzmöglichkeiten	
		Durchmesser	Länge	Lebensdauer	Brennstellung	Kühlung
SIRIUS HRI 382 W S		58.0 mm	72.0 mm	2500 h		
SIRIUS HRI 420 W		58.0 mm	72.0 mm	2500 h		
SIRIUS HRI 420 W S		58.0 mm	72.0 mm	2500 h		
SIRIUS HRI 440 W	8.0 mm	58.0 mm	71.0 mm	1500 h	Beliebig	Forciert
SIRIUS HRI 440 W +		58.0 mm	71.0 mm	1500 h		
SIRIUS HRI 440 W H		65.0 mm	60.0 mm	1500 h	Beliebig	
SIRIUS HRI 440 W S		11.8 mm	71.0 mm	1500 h	Beliebig	
SIRIUS HRI 440 W X		58.0 mm	71.0 mm	1500 h		
SIRIUS HRI 461 W		60.0 mm	67.0 mm	1500 h	Beliebig	
SIRIUS HRI 461 W S		60.0 mm	67.0 mm	1500 h	Beliebig	
SIRIUS HRI 462 W		58.0 mm	72.0 mm	2000 h		
SIRIUS HRI 470 W		58.0 mm	71.0 mm	1500 h	Beliebig	
SIRIUS HRI 470 W S		58.0 mm	71.0 mm	1500 h	Beliebig	
SIRIUS HRI 470 W RO		60.0 mm	67.0 mm	1500 h	Beliebig	
SIRIUS HRI 470 W XL		60.0 mm	67.0 mm	1500 h	Beliebig	
SIRIUS HRI 471 W SN		60.0 mm	67.0 mm	1500 h	Beliebig	
SIRIUS HRI 550 W		60.0 mm	67.0 mm	1500 h		
SIRIUS HRI 550 W XL		60.0 mm	67.0 mm	1500 h		
HRI 580 W F		65.0 mm	65.0 mm	1000 h		

Produkt-Bezeichnung	Zertifikate & Standards	Umwelt Informationen Informationen gemäß Art. 33 der EU Richtlinie (EC) 1907/2006 (REACH)		
	EEI – Energieeffizienz-klasse	Datum der Deklaration	Primäre Erzeugnisnummer	Stoff der Kandidatenliste 1
SIRIUS HRI 100 W	B	06-03-2024	4052899321656   4052899329119	No declarable substances contained
SIRIUS HRI 132 W SC	A	06-03-2024	4052899011335   4052899028708   4052899197404	No declarable substances contained
SIRIUS HRI 140 W RO	A	06-03-2024	4052899224056   4052899258969	No declarable substances contained
SIRIUS HRI 190 W+		07-03-2024	4008321866592   4052899475397	No declarable substances contained
SIRIUS HRI 230 W	A	05-03-2024	4008321678225   4008321810311	No declarable substances contained
SIRIUS HRI 231 W	A	06-03-2024	4052899512634   4052899553521   4062172041430   4062172128681   4062172212311	No declarable substances contained
SIRIUS HRI 251 W		07-03-2024	4062172212458   4062172212434	No declarable substances contained
SIRIUS HRI 260 W PRO		07-03-2024	4062172118941   4062172118927	No declarable substances contained
SIRIUS HRI 280 W	A	05-03-2024	4008321734303   4008321810342	No declarable substances contained

Produkt-Bezeichnung	Zertifikate & Standards	Umwelt Informationen Informationen gemäß Art. 33 der EU Richtlinie (EC) 1907/2006 (REACH)		
	EEI – Energieeffizienz- klasse	Datum der Deklaration	Primäre Erzeugnisnummer	Stoff der Kandidatenliste 1
SIRIUS HRI 280 W RO	A	06-03-2024	4052899082151   4052899110397	No declarable substances contained
SIRIUS HRI 281 W	A	06-03-2024	4052899553552   4062172041454   4062172128704	No declarable substances contained
SIRIUS HRI 295 W		26-10-2023	4062172283328   4062172283304	No declarable substances contained
SIRIUS HRI 310 W		07-12-2023	4062172202169   4062172202183	
SIRIUS HRI 310 W RO		07-12-2023	4062172013536   4062172063449   4062172140867   4062172140843	No declarable substances contained
SIRIUS HRI 310 W PRO		07-03-2024	4062172085304   4062172169424   4062172169455	No declarable substances contained
SIRIUS HRI 311 W		07-03-2024	4062172169363	
SIRIUS HRI 330 W		05-03-2024	4008321754448   4008321810373	No declarable substances contained
SIRIUS HRI 330 W X8	A	06-03-2024	4052899140295   4052899140325   4052899224346	No declarable substances contained
SIRIUS HRI 330 W XL		06-03-2024	4008321848765   4052899195431	No declarable substances contained
SIRIUS HRI 371 W		06-03-2024	4062172057004   4062172056984   4052899558649   4052899558670	No declarable substances contained
SIRIUS HRI 371 W S		06-03-2024	4062172056953   4062172056939   4052899558618	No declarable substances contained
SIRIUS HRI 371 W +		07-03-2024	4062172110341   4062172110327	No declarable substances contained
HRI 371 W S +		15-03-2024	4062172110396   4062172110372   4062172390729	No declarable substances contained
SIRIUS HRI 381 W S		22-12-2023	4062172226240   4062172226226	No declarable substances contained
SIRIUS HRI 380 W Pro		07-03-2024	4062172168625   4062172168601	No declarable substances contained
SIRIUS HRI 380 W S PRO		22-12-2023	4062172168335   4062172168311	No declarable substances contained
SIRIUS HRI 382 W		07-12-2023	4062172047135   4062172326131	No declarable substances contained
SIRIUS HRI 382 W S		07-12-2023	4062172033541   4062172326100	No declarable substances contained
SIRIUS HRI 420 W		07-03-2024	4062172192750   4062172192736	No declarable substances contained



## Familiendatenblatt

Produkt-Bezeichnung	Zertifikate & Standards	Umwelt Informationen Informationen gemäß Art. 33 der EU Richtlinie (EC) 1907/2006 (REACH)		
	EEI – Energieeffizienz- klasse	Datum der Deklaration	Primäre Erzeugnisnummer	Stoff der Kandidatenliste 1
SIRIUS HRI 420 W S		26-10-2023	4062172192705   4062172192682   4062172392938   4062172392891   4062172393225   4062172393201	No declarable substances contained
SIRIUS HRI 440 W	A	06-03-2024	4052899222212   4052899259096   4052899553644   4052899570566   4052899587892	No declarable substances contained
SIRIUS HRI 440 W +		22-12-2023	4062172047333   4062172348874	No declarable substances contained
SIRIUS HRI 440 W H		06-03-2024	4052899509528   4052899576735	No declarable substances contained
SIRIUS HRI 440 W S	A	06-03-2024	4052899276543   4052899329140	No declarable substances contained
SIRIUS HRI 440 W X		07-03-2024	4062172017442	No declarable substances contained
SIRIUS HRI 461 W		06-03-2024	4052899532274   4052899553613	No declarable substances contained
SIRIUS HRI 461 W S		06-03-2024	4052899532298   4052899553583	No declarable substances contained
SIRIUS HRI 462 W		26-10-2023	4062172302128   4062172302104	No declarable substances contained
SIRIUS HRI 470 W		22-12-2023	4052899580961   4062172169332	No declarable substances contained
SIRIUS HRI 470 W S		06-03-2024	4052899580985   4062172169301	No declarable substances contained
SIRIUS HRI 470 W RO	A	17-05-2024	4052899476998   4052899477018   4062172392556	No declarable substances contained
SIRIUS HRI 470 W XL		06-03-2024	4052899581166   4062172017473   4062172168281	No declarable substances contained
SIRIUS HRI 471 W SN		06-03-2024	4052899581005   4062172040358	No declarable substances contained
SIRIUS HRI 550 W		06-03-2024	4062172008761   4062172078122	No declarable substances contained
SIRIUS HRI 550 W XL		27-10-2023	4062172008785   4062172168236   4062172168212	No declarable substances contained
HRI 580 W F		22-12-2023	4062172085267	No declarable substances contained

Produkt-Bezeichnung	SCIP Deklarationsnummer
SIRIUS HRI 100 W	Kein deklarationspflichtige r Stoff enthalten
SIRIUS HRI 132 W SC	In Vorbereitung
SIRIUS HRI 140 W RO	In Vorbereitung
SIRIUS HRI 190 W+	In Vorbereitung
SIRIUS HRI 230 W	In Vorbereitung
SIRIUS HRI 231 W	In Vorbereitung
SIRIUS HRI 251 W	Kein deklarationspflichtige r Stoff enthalten
SIRIUS HRI 260 W PRO	In Vorbereitung
SIRIUS HRI 280 W	In Vorbereitung
SIRIUS HRI 280 W RO	In Vorbereitung
SIRIUS HRI 281 W	In Vorbereitung
SIRIUS HRI 295 W	Kein deklarationspflichtige r Stoff enthalten
SIRIUS HRI 310 W	In Vorbereitung
SIRIUS HRI 310 W RO	In Vorbereitung
SIRIUS HRI 310 W PRO	In Vorbereitung
SIRIUS HRI 311 W	In Vorbereitung
SIRIUS HRI 330 W	In Vorbereitung
SIRIUS HRI 330 W X8	In Vorbereitung
SIRIUS HRI 330 W XL	In Vorbereitung
SIRIUS HRI 371 W	In Vorbereitung
SIRIUS HRI 371 W S	In Vorbereitung
SIRIUS HRI 371 W +	In Vorbereitung
HRI 371 W S +	In Vorbereitung
SIRIUS HRI 381 W S	In Vorbereitung
SIRIUS HRI 380 W Pro	In Vorbereitung
SIRIUS HRI 380 W S PRO	Kein deklarationspflichtige r Stoff enthalten
SIRIUS HRI 382 W	In Vorbereitung
SIRIUS HRI 382 W S	Kein deklarationspflichtige r Stoff enthalten
SIRIUS HRI 420 W	In Vorbereitung
SIRIUS HRI 420 W S	In Vorbereitung
SIRIUS HRI 440 W	In Vorbereitung
SIRIUS HRI 440 W +	Kein deklarationspflichtige r Stoff enthalten
SIRIUS HRI 440 W H	In Vorbereitung
SIRIUS HRI 440 W S	In Vorbereitung

## Familiendatenblatt

<b>Produkt-Bezeichnung</b>	<b>SCIP Deklarationsnummer</b>
SIRIUS HRI 440 W X	Kein deklarationspflichtige r Stoff enthalten
SIRIUS HRI 461 W	Kein deklarationspflichtige r Stoff enthalten
SIRIUS HRI 461 W S	Kein deklarationspflichtige r Stoff enthalten
SIRIUS HRI 462 W	Kein deklarationspflichtige r Stoff enthalten
SIRIUS HRI 470 W	Kein deklarationspflichtige r Stoff enthalten
SIRIUS HRI 470 W S	In Vorbereitung
SIRIUS HRI 470 W RO	In Vorbereitung
SIRIUS HRI 470 W XL	In Vorbereitung
SIRIUS HRI 471 W SN	In Vorbereitung
SIRIUS HRI 550 W	In Vorbereitung
SIRIUS HRI 550 W XL	In Vorbereitung
HRI 580 W F	Kein deklarationspflichtige r Stoff enthalten

## Familiendatenblatt

---

### Sicherheitshinweise

Wegen ihrer hohen Leuchtdichte, der abgegebenen UV-Strahlung und des hohen Lampeninnendruckes während des Betriebs dürfen SIRIUS HRI-Lampen nur in geschlossenen und eigens dafür konstruierten Gehäusen betrieben werden. Durch passende Filter muss sichergestellt werden, dass die UV-Strahlung auf ein akzeptables Niveau verringert wird. Im Falle des Platzens einer Lampe wird Quecksilber freigesetzt. Es sind besondere Sicherheitsregeln zu beachten. Nähere Hinweise hierzu erhalten Sie auf Anfrage oder entnehmen Sie bitte dem Beipackzettel bzw. der Bedienungsanleitung.

---

### Anwendungshinweis

Für weitere Anwendungsinformationen beachten Sie bitte das Produktdatenblatt.

---

### Haftungsausschluss

Änderungen und Irrtümer vorbehalten. Vergewissern Sie sich, dass Sie immer den neuesten Stand verwenden.