

SIRIUS HRI

High-pressure discharge lamps with reflector



Areas of application

- Concert lighting
- Club and disco
- Stage and theatre
- Studio, TV and film
- Architecture & Architainment

Product family benefits

- Lightweight and compact reflector lamps
- Perfectly suited for small and lightweight moving heads
- Optimized burner design allows any burning position
- High luminance through very short arc and high pressure
- Bright light for brilliant light effects
- Long lifetime
- Easy lamp replacement
- Stable light output over the entire lifetime



Product family datasheet

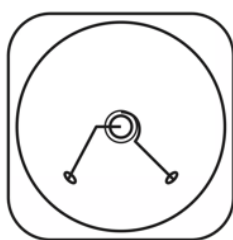
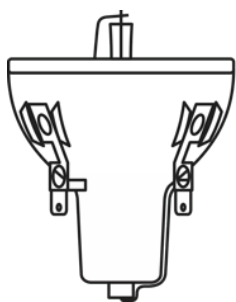

666507_SIRIUS HRI 100W

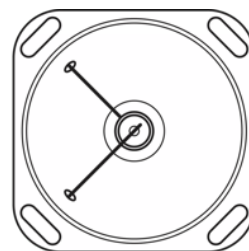
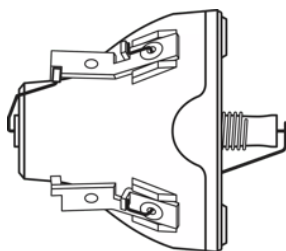

350611_SIRIUS HRI 132W

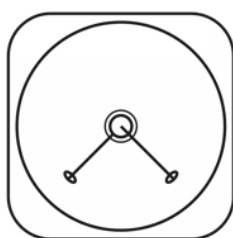
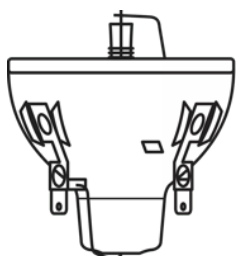

488735_SIRIUS HRI 132W

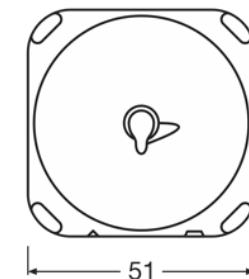
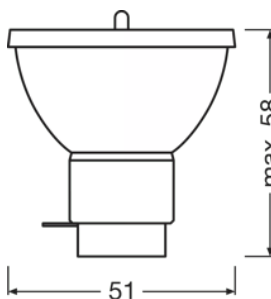

SIRIUS HRI 251W

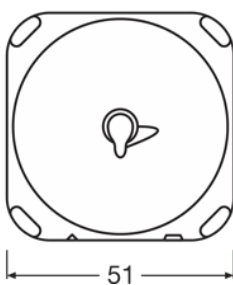
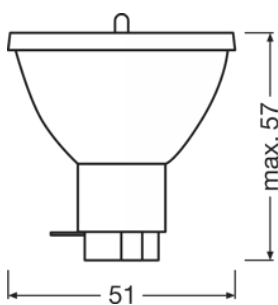

SIRIUS HRI 295 W

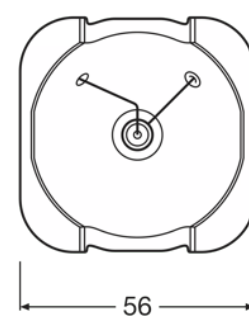
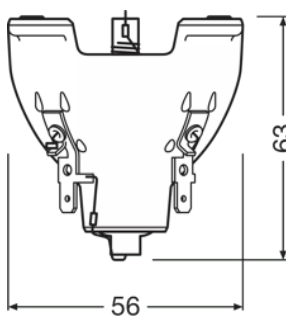

501950_SIRIUS HRI 330W

Product family datasheet

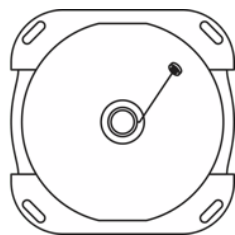
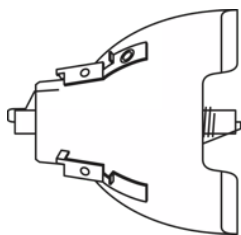

333382_SIRIUS HRI 330W

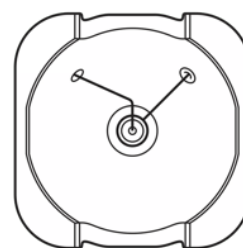
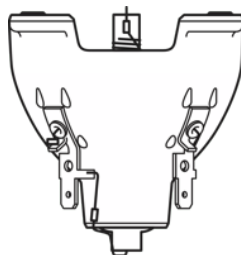

501965_SIRIUS HRI 330W

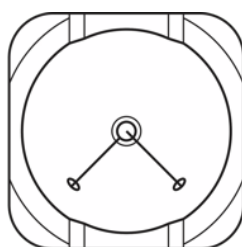
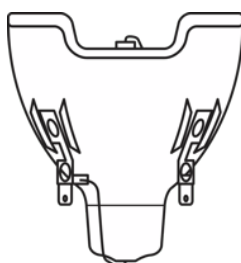

488771_SIRIUS HRI 330W X8

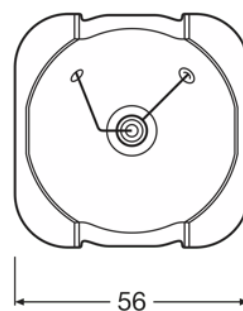
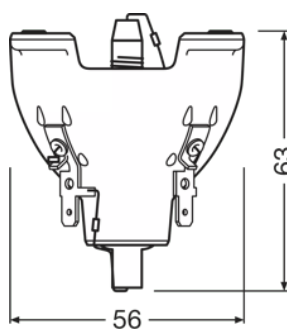

501949_Sirius HRI 330W XL

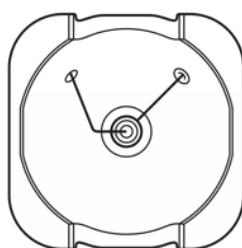
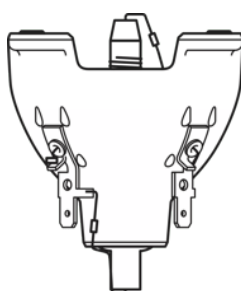

501963_Sirius HRI 330W XL

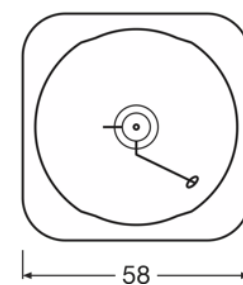
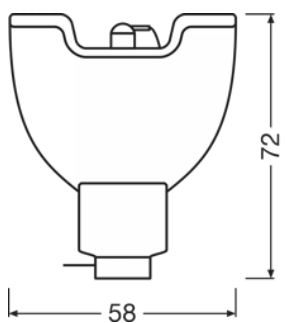

SIRIUS HRI 371W

Product family datasheet

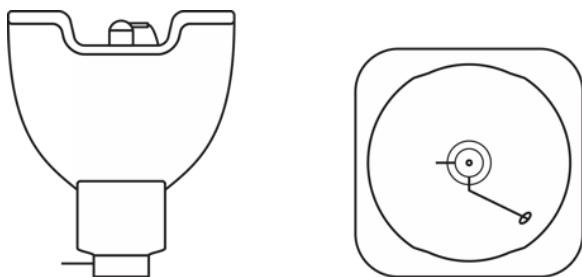

SIRIUS HRI 371W

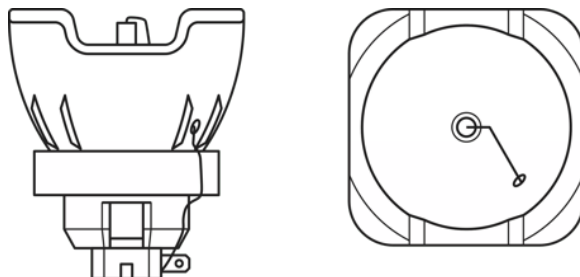

668858_SIRIUS HRI 440W

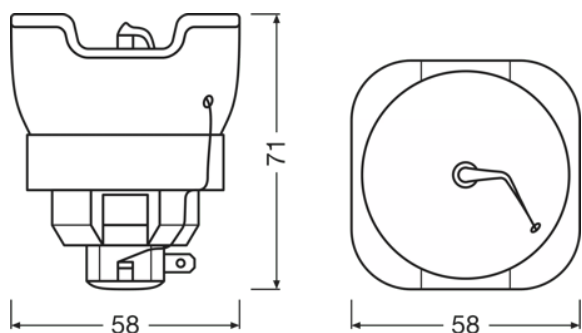

SIRIUS HRI 580 F

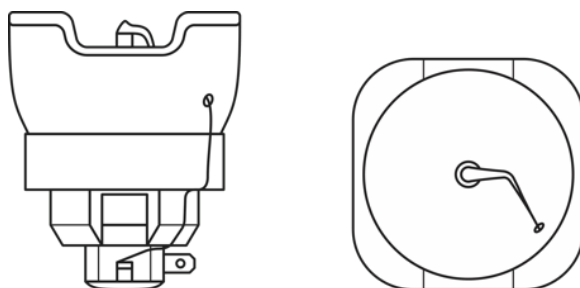

SIRIUS HRI 580 F

Product family datasheet

Technical data

Product description	Electrical data		Photometrical data				Light technical data
	Nominal wattage	Nominal current	Nominal luminous flux	Color temperature	Color rendering index Ra	Maximum color temperature	Focal length
SIRIUS HRI 100 W	100.00 W	18 A	3680 lm	9000 K	60	9300 K	30.0 mm
SIRIUS HRI 132 W SC	132.00 W	18 A	5150 lm	9200 K	60	9200 K	37.7 mm
SIRIUS HRI 140 W RO	140.00 W	19 A	5400 lm	9200 K	60	9200 K	37.7 mm
SIRIUS HRI 190 W+	190.00 W	27 A	8100 lm	8200 K	73		
SIRIUS HRI 230 W	230.00 W	33 A	9500 lm	8000 K	75	8000 K	34.5 mm
SIRIUS HRI 231 W	231.00 W	33 A	10800 lm	8000 K	75		
SIRIUS HRI 251 W	250.00 W	35 A	12000 lm	8000 K	77		
SIRIUS HRI 260 W PRO	260.00 W	37 A	13500 lm	7800 K	79		
SIRIUS HRI 280 W	280.00 W	4 A	11500 lm	7800 K	78	7800 K	35.5 mm
SIRIUS HRI 280 W RO	280.00 W	4 A	11500 lm	7800 K	78		
SIRIUS HRI 281 W	281.00 W	4 A	13000 lm	7800 K	78		
SIRIUS HRI 295 W	295.00 W	4.1 A	11300 lm	7800 K	78		
SIRIUS HRI 310 W	310.00 W	45 A	15000 lm	8000 K	84		
SIRIUS HRI 310 W RO	310.00 W	48 A	13000 lm	8500 K	78		
SIRIUS HRI 310 W PRO	310.00 W	5 A	15500 lm	7650 K	85		
SIRIUS HRI 311 W	310.00 W	33 A	14500 lm	8000 K	75		
SIRIUS HRI 330 W	330.00 W	5 A	18000 lm	7400 K	86	7400 K	31.0 mm
SIRIUS HRI 330 W X8	330.00 W	44 A	18000 lm	8000 K	85		
SIRIUS HRI 330 W XL	330.00 W	5 A	16500 lm	7250 K	71		
SIRIUS HRI 371 W	371.00 W	5 A	18300 lm	7650 K	85		
SIRIUS HRI 371 W S	371.00 W	5 A	19800 lm	7650 K	85		
SIRIUS HRI 371 W +	370.00 W	5 A	18300 lm	7650 K	85		
HRI 371 W S +	370.00 W	5 A	19800 lm	7650 K	85		
SIRIUS HRI 381 W S	380.00 W	5 A	20000 lm	7700 K	85		
SIRIUS HRI 380 W Pro	380.00 W	5 A	20000 lm	7700 K	85		
SIRIUS HRI 380 W S PRO	380.00 W	5 A	20000 lm	7700 K	85		
SIRIUS HRI 382 W	382.00 W	54 A	21000 lm	7650 K	85		
SIRIUS HRI 382 W S	380.00 W	54 A	20000 lm	7650 K	85		
SIRIUS HRI 420 W	420.00 W	5 A	22000 lm	7700 K	85		
SIRIUS HRI 420 W S	420.00 W	5 A	21000 lm	7700 K	85		
SIRIUS HRI 440 W	440.00 W	53 A	20000 lm	7000 K	80	7000 K	41.0 mm
SIRIUS HRI 440 W +	440.00 W	53 A	22800 lm	7000 K	80		
SIRIUS HRI 440 W H	440.00 W	53 A	18000 lm	7000 K	75		
SIRIUS HRI 440 W S	440.00 W	44 A	22800 lm	7000 K	80		
SIRIUS HRI 440 W X	440.00 W	53 A	22800 lm	7000 K	80		
SIRIUS HRI 461 W	461.00 W	53 A	24000 lm	7500 K	80		
SIRIUS HRI 461 W S	461.00 W	53 A	24000 lm	7500 K	80		
SIRIUS HRI 462 W	295.00 W	6.20 A	24000 lm	7900 K	85		

Product family datasheet

Product description	Electrical data		Photometrical data				Light technical data
	Nominal wattage	Nominal current	Nominal luminous flux	Color temperature	Color rendering index Ra	Maximum color temperature	Focal length
SIRIUS HRI 470 W	470.00 W	53 A	20500 lm	7000 K	80		
SIRIUS HRI 470 W S	470.00 W	53 A	21500 lm	7000 K	80		
SIRIUS HRI 470 W RO	470.00 W	53 A	19500 lm	7500 K	80		
SIRIUS HRI 470 W XL	470.00 W	53 A	24000 lm	7500 K	80		
SIRIUS HRI 471 W SN	471.00 W	53 A	20000 lm	7500 K	80		
SIRIUS HRI 550 W	550.00 W	6.1 A	28000 lm	7000 K	75		
SIRIUS HRI 550 W XL	550.00 W	6.1 A	28000 lm	7500 K	75		
HRI 580 W F	580.00 W	61 A	29500 lm	7000 K	75		

Product description	Aperture window, maximum	Dimensions & weight		Lifespan	Capabilities	
		Diameter	Length	Lifespan	Burning position	Cooling
SIRIUS HRI 100 W	5x3.8 mm	45.0 mm	53.0 mm	6000 h	Any	Forced
SIRIUS HRI 132 W SC	5x3.8 mm	46.0 mm	max. 44 mm	6000 h	Any	Forced
SIRIUS HRI 140 W RO	5x3.8 mm	46.0 mm	max. 44 mm	6000 h	Any	Forced
SIRIUS HRI 190 W+		51.0 mm	54.5 mm	3000 h		
SIRIUS HRI 230 W	5x3.8 mm	51.0 mm	54.5 mm	2500 h	Any	Forced
SIRIUS HRI 231 W		51.0 mm	50.0 mm	2000 h	Any	
SIRIUS HRI 251 W		51.0 mm	61.0 mm	3000 h		
SIRIUS HRI 260 W PRO		51.0 mm	50.0 mm	6000 h		
SIRIUS HRI 280 W	5x3.8 mm	51.0 mm	54.5 mm	2000 h	Any	Forced
SIRIUS HRI 280 W RO		51.0 mm	54.5 mm	2000 h	Any	
SIRIUS HRI 281 W		51.0 mm	50.0 mm	2000 h	Any	
SIRIUS HRI 295 W		51.0 mm	53.5 mm	2500 h		
SIRIUS HRI 310 W		51.0 mm	53.5 mm	2500 h		
SIRIUS HRI 310 W RO		60.0 mm	67.0 mm	4000 h	Any	
SIRIUS HRI 310 W PRO		58.0 mm	72.0 mm	6000 h		
SIRIUS HRI 311 W		51.0 mm	50.0 mm	1500 h		
SIRIUS HRI 330 W	8.0 mm	56.0 mm	63.0 mm	1500 h	Any	Forced
SIRIUS HRI 330 W X8		58.0 mm	66.0 mm	1500 h	Any	
SIRIUS HRI 330 W XL		56.0 mm	63.0 mm	1500 h	Any	
SIRIUS HRI 371 W		58.0 mm	72.0 mm	1500 h	Any	
SIRIUS HRI 371 W S		58.0 mm	72.0 mm	1500 h	Any	
SIRIUS HRI 371 W +		58.0 mm	72.0 mm	3000 h		
HRI 371 W S +		58.0 mm	72.0 mm	3000 h		
SIRIUS HRI 381 W S		58.0 mm	72.0 mm	2500 h		
SIRIUS HRI 380 W Pro		58.0 mm	72.0 mm	2500 h		
SIRIUS HRI 380 W S PRO		58.0 mm	72.0 mm	6000 h		
SIRIUS HRI 382 W		58.0 mm	72.0 mm	2500 h		
SIRIUS HRI 382 W S		58.0 mm	72.0 mm	2500 h		
SIRIUS HRI 420 W		58.0 mm	72.0 mm	2500 h		

Product family datasheet

Product description	Aperture window, maximum	Dimensions & weight		Lifespan	Capabilities	
		Diameter	Length	Lifespan	Burning position	Cooling
SIRIUS HRI 420 W S		58.0 mm	72.0 mm	2500 h		
SIRIUS HRI 440 W	8.0 mm	58.0 mm	71.0 mm	1500 h	Any	Forced
SIRIUS HRI 440 W +		58.0 mm	71.0 mm	1500 h		
SIRIUS HRI 440 W H		65.0 mm	60.0 mm	1500 h	Any	
SIRIUS HRI 440 W S		11.8 mm	71.0 mm	1500 h	Any	
SIRIUS HRI 440 W X		58.0 mm	71.0 mm	1500 h		
SIRIUS HRI 461 W		60.0 mm	67.0 mm	1500 h	Any	
SIRIUS HRI 461 W S		60.0 mm	67.0 mm	1500 h	Any	
SIRIUS HRI 462 W		58.0 mm	72.0 mm	2000 h		
SIRIUS HRI 470 W		58.0 mm	71.0 mm	1500 h	Any	
SIRIUS HRI 470 W S		58.0 mm	71.0 mm	1500 h	Any	
SIRIUS HRI 470 W RO		60.0 mm	67.0 mm	1500 h	Any	
SIRIUS HRI 470 W XL		60.0 mm	67.0 mm	1500 h	Any	
SIRIUS HRI 471 W SN		60.0 mm	67.0 mm	1500 h	Any	
SIRIUS HRI 550 W		60.0 mm	67.0 mm	1500 h		
SIRIUS HRI 550 W XL		60.0 mm	67.0 mm	1500 h		
HRI 580 W F		65.0 mm	65.0 mm	1000 h		

Product description	Certificates & standards	Environmental information Information according Art. 33 of EU Regulation (EC) 1907/2006 (REACH)		
	EEI – Energy Label	Date of Declaration	Primary Article Identifier	Candidate List Substance 1
SIRIUS HRI 100 W	B	06-03-2024	4052899321656 4052899329119	No declarable substances contained
SIRIUS HRI 132 W SC	A	06-03-2024	4052899011335 4052899028708 4052899197404	No declarable substances contained
SIRIUS HRI 140 W RO	A	06-03-2024	4052899224056 4052899258969	No declarable substances contained
SIRIUS HRI 190 W+		07-03-2024	4008321866592 4052899475397	No declarable substances contained
SIRIUS HRI 230 W	A	05-03-2024	4008321678225 4008321810311	No declarable substances contained
SIRIUS HRI 231 W	A	06-03-2024	4052899512634 4052899553521 4062172041430 4062172128681 4062172212311	No declarable substances contained
SIRIUS HRI 251 W		07-03-2024	4062172212458 4062172212434	No declarable substances contained
SIRIUS HRI 260 W PRO		07-03-2024	4062172118941 4062172118927	No declarable substances contained
SIRIUS HRI 280 W	A	05-03-2024	4008321734303 4008321810342	No declarable substances contained
SIRIUS HRI 280 W RO	A	06-03-2024	4052899082151 4052899110397	No declarable substances contained

Product family datasheet

Product description	Certificates & standards	Environmental information Information according Art. 33 of EU Regulation (EC) 1907/2006 (REACH)		
	EEI – Energy Label	Date of Declaration	Primary Article Identifier	Candidate List Substance 1
SIRIUS HRI 281 W	A	06-03-2024	4052899553552 4062172041454 4062172128704	No declarable substances contained
SIRIUS HRI 295 W		26-10-2023	4062172283328 4062172283304	No declarable substances contained
SIRIUS HRI 310 W		07-12-2023	4062172202169 4062172202183	
SIRIUS HRI 310 W RO		07-12-2023	4062172013536 4062172063449 4062172140867 4062172140843	No declarable substances contained
SIRIUS HRI 310 W PRO		07-03-2024	4062172085304 4062172169424 4062172169455	No declarable substances contained
SIRIUS HRI 311 W		07-03-2024	4062172169363	
SIRIUS HRI 330 W		05-03-2024	4008321754448 4008321810373	No declarable substances contained
SIRIUS HRI 330 W X8	A	06-03-2024	4052899140295 4052899140325 4052899224346	No declarable substances contained
SIRIUS HRI 330 W XL		06-03-2024	4008321848765 4052899195431	No declarable substances contained
SIRIUS HRI 371 W		06-03-2024	4062172057004 4062172056984 4052899558649 4052899558670	No declarable substances contained
SIRIUS HRI 371 W S		06-03-2024	4062172056953 4062172056939 4052899558618	No declarable substances contained
SIRIUS HRI 371 W +		07-03-2024	4062172110341 4062172110327	No declarable substances contained
HRI 371 W S +		15-03-2024	4062172110396 4062172110372 4062172390729	No declarable substances contained
SIRIUS HRI 381 W S		22-12-2023	4062172226240 4062172226226	No declarable substances contained
SIRIUS HRI 380 W Pro		07-03-2024	4062172168625 4062172168601	No declarable substances contained
SIRIUS HRI 380 W S PRO		22-12-2023	4062172168335 4062172168311	No declarable substances contained
SIRIUS HRI 382 W		07-12-2023	4062172047135 4062172326131	No declarable substances contained
SIRIUS HRI 382 W S		07-12-2023	4062172033541 4062172326100	No declarable substances contained
SIRIUS HRI 420 W		07-03-2024	4062172192750 4062172192736	No declarable substances contained

Product family datasheet

Product description	Certificates & standards	Environmental information Information according Art. 33 of EU Regulation (EC) 1907/2006 (REACH)		
	EEI – Energy Label	Date of Declaration	Primary Article Identifier	Candidate List Substance 1
SIRIUS HRI 420 W S		26-10-2023	4062172192705 4062172192682 4062172392938 4062172392891 4062172393225 4062172393201	No declarable substances contained
SIRIUS HRI 440 W	A	06-03-2024	4052899222212 4052899259096 4052899553644 4052899570566 4052899587892	No declarable substances contained
SIRIUS HRI 440 W +		22-12-2023	4062172047333 4062172348874	No declarable substances contained
SIRIUS HRI 440 W H		06-03-2024	4052899509528 4052899576735	No declarable substances contained
SIRIUS HRI 440 W S	A	06-03-2024	4052899276543 4052899329140	No declarable substances contained
SIRIUS HRI 440 W X		07-03-2024	4062172017442	No declarable substances contained
SIRIUS HRI 461 W		06-03-2024	4052899532274 4052899553613	No declarable substances contained
SIRIUS HRI 461 W S		06-03-2024	4052899532298 4052899553583	No declarable substances contained
SIRIUS HRI 462 W		26-10-2023	4062172302128 4062172302104	No declarable substances contained
SIRIUS HRI 470 W		22-12-2023	4052899580961 4062172169332	No declarable substances contained
SIRIUS HRI 470 W S		06-03-2024	4052899580985 4062172169301	No declarable substances contained
SIRIUS HRI 470 W RO	A	17-05-2024	4052899476998 4052899477018 4062172392556	No declarable substances contained
SIRIUS HRI 470 W XL		06-03-2024	4052899581166 4062172017473 4062172168281	No declarable substances contained
SIRIUS HRI 471 W SN		06-03-2024	4052899581005 4062172040358	No declarable substances contained
SIRIUS HRI 550 W		06-03-2024	4062172008761 4062172078122	No declarable substances contained
SIRIUS HRI 550 W XL		27-10-2023	4062172008785 4062172168236 4062172168212	No declarable substances contained
HRI 580 W F		22-12-2023	4062172085267	No declarable substances contained

Product family datasheet

Product description	Declaration No. in SCIP database
SIRIUS HRI 100 W	No declarable substances contained
SIRIUS HRI 132 W SC	In work
SIRIUS HRI 140 W RO	In work
SIRIUS HRI 190 W+	In work
SIRIUS HRI 230 W	In work
SIRIUS HRI 231 W	In work
SIRIUS HRI 251 W	No declarable substances contained
SIRIUS HRI 260 W PRO	In work
SIRIUS HRI 280 W	In work
SIRIUS HRI 280 W RO	In work
SIRIUS HRI 281 W	In work
SIRIUS HRI 295 W	No declarable substances contained
SIRIUS HRI 310 W	In work
SIRIUS HRI 310 W RO	In work
SIRIUS HRI 310 W PRO	In work
SIRIUS HRI 311 W	In work
SIRIUS HRI 330 W	In work
SIRIUS HRI 330 W X8	In work
SIRIUS HRI 330 W XL	In work
SIRIUS HRI 371 W	In work
SIRIUS HRI 371 W S	In work
SIRIUS HRI 371 W +	In work
HRI 371 W S +	In work
SIRIUS HRI 381 W S	In work
SIRIUS HRI 380 W Pro	In work
SIRIUS HRI 380 W S PRO	No declarable substances contained
SIRIUS HRI 382 W	In work
SIRIUS HRI 382 W S	No declarable substances contained
SIRIUS HRI 420 W	In work
SIRIUS HRI 420 W S	In work
SIRIUS HRI 440 W	In work
SIRIUS HRI 440 W +	No declarable substances contained
SIRIUS HRI 440 W H	In work
SIRIUS HRI 440 W S	In work
SIRIUS HRI 440 W X	No declarable substances contained
SIRIUS HRI 461 W	No declarable substances contained
SIRIUS HRI 461 W S	No declarable substances contained

Product family datasheet

Product description	Declaration No. in SCIP database
SIRIUS HRI 462 W	No declarable substances contained
SIRIUS HRI 470 W	No declarable substances contained
SIRIUS HRI 470 W S	In work
SIRIUS HRI 470 W RO	In work
SIRIUS HRI 470 W XL	In work
SIRIUS HRI 471 W SN	In work
SIRIUS HRI 550 W	In work
SIRIUS HRI 550 W XL	In work
HRI 580 W F	No declarable substances contained

Product family datasheet

Safety advice

Because of their high luminance, UV radiation and high internal pressure during operation, SIRIUS HRI lamps may only be operated in enclosed lamp casings specially constructed for the purpose. Appropriate filters must ensure that UV radiation is reduced to an acceptable level. Mercury is released if the lamp breaks. Special safety precautions must be taken. Information on safety and handling is available on request or can be found in the leaflet included with the lamp or in the operating instructions.

Application advice

For more detailed application information and graphics please see product datasheet.

Disclaimer

Subject to change without notice. Errors and omission excepted. Always make sure to use the most recent release.