

## SIRIUS HRI

High pressure discharge lamps designed to provide brilliant light effects.



### Areas of application

- Concert Lighting
- Club & Disco
- Stage & Theatre
- Studio, TV, & Film
- Architecture & Architainment

### Product features and benefits

- Lightweight and compact reflector lamps with ECG
- High luminance through very short arc and high pressure
- Produces brilliant light effects
- Stable light output over the entire lifetime
- Long lifetime
- Easy lamp replacement
- Approved by leading moving lighting fixture companies



## Product family datasheet

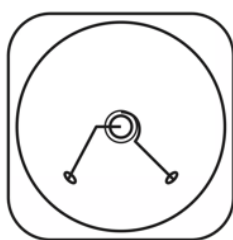
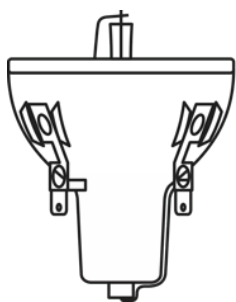

SIRIUS HRI 100W

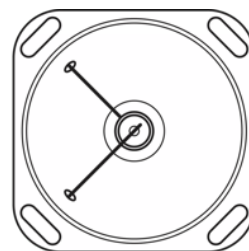
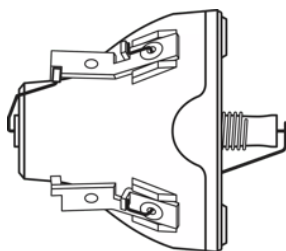

SIRIUS HRI 132W

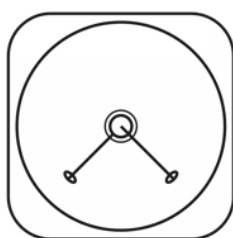
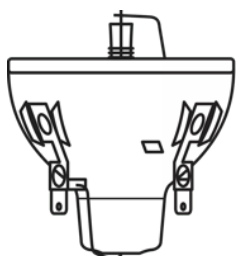

SIRIUS HRI 132W

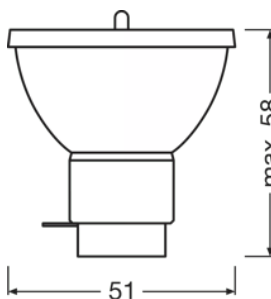

SIRIUS HRI 251W

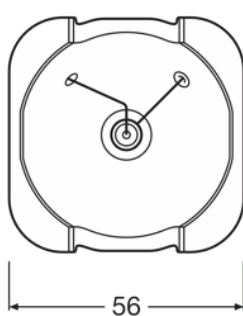
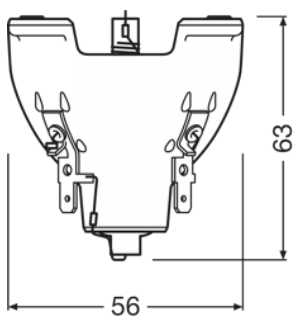

SIRIUS HRI 330W

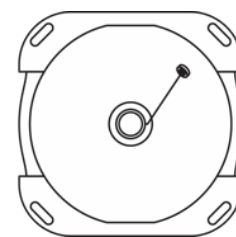
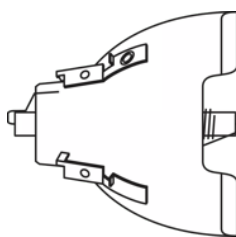

SIRIUS HRI 330W

## Product family datasheet

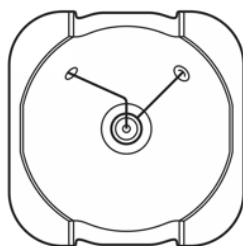
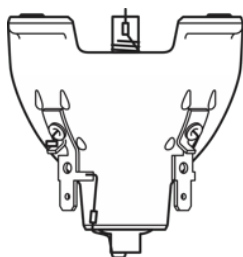

SIRIUS HRI 330W

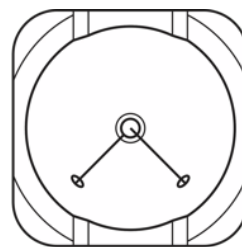
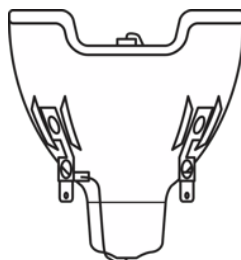

SIRIUS HRI 330W X8

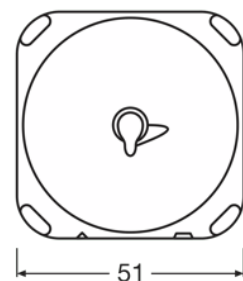
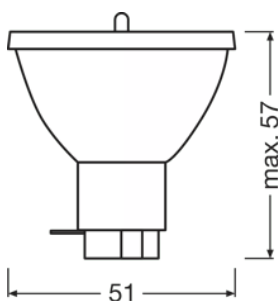

SIRIUS HRI 295 W

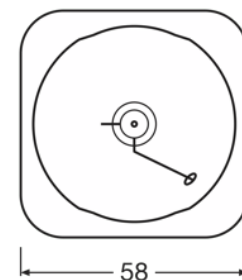
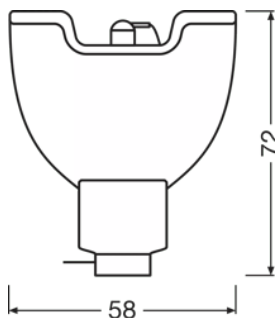

SIRIUS HRI 371W

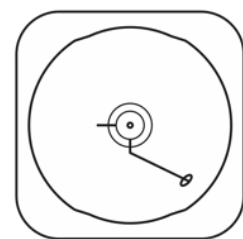
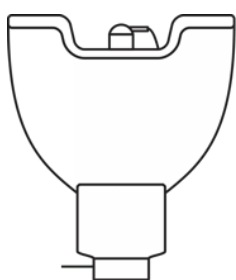

SIRIUS HRI 371W

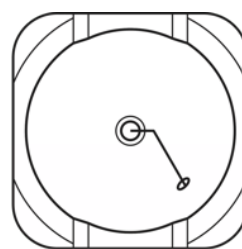
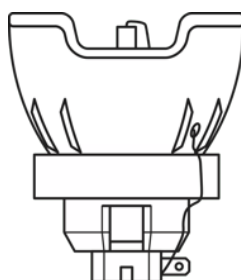

SIRIUS HRI 440W

Product family datasheet

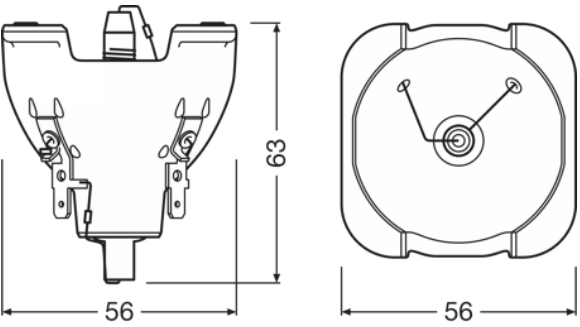

Sirius HRI 330W XL

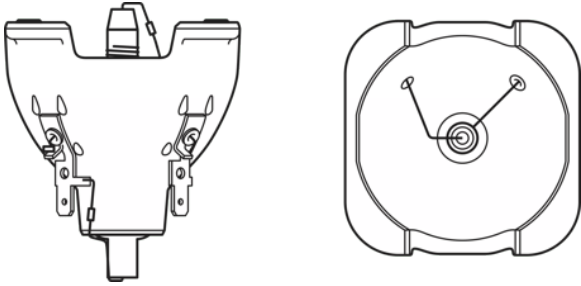

Sirius HRI 330W XL

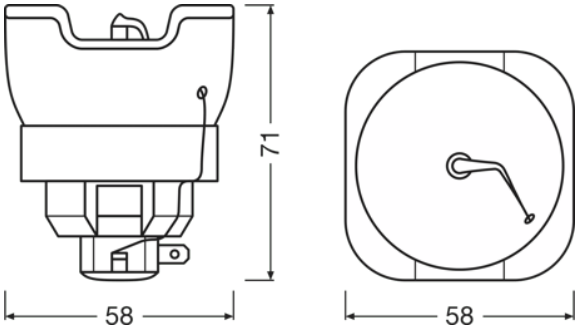

SIRIUS HRI 580 F

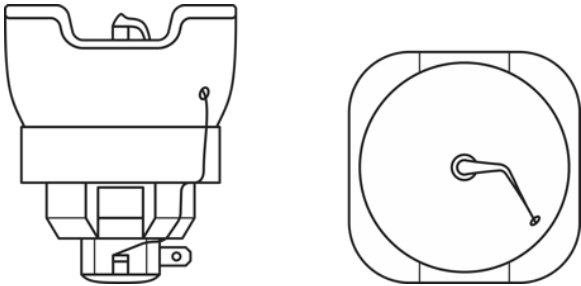

SIRIUS HRI 580 F

## Product family datasheet

### Technical data

Product description	General Product Information	Electrical Data	Photometric Data	
	Category	Nominal wattage	Nominal luminous flux	Working distance
SIRIUS HRI 100 W	CORE	100 W	3680 lm	30 mm
SIRIUS HRI 132 W SC	CORE	132 W	5150 lm	37.7 mm
SIRIUS HRI 190 W+	CORE	190 W	8100 lm	34.5 mm
SIRIUS HRI 230 W	CORE	230 W	9500 lm	34.5 mm
SIRIUS HRI 231 W	VALUE	231 W	10800 lm	34.5 mm
SIRIUS HRI 280 W	CORE	280 W	11500 lm	34.5 mm
SIRIUS HRI 251 W	VALUE	251 W	12000 lm	38 mm
SIRIUS HRI 281 W	VALUE	281 W	13000 lm	34.5 mm
SIRIUS HRI 260 W PRO	PRO	260 W	13500 lm	34.5 mm
SIRIUS HRI 330 W	CORE	330 W	18000 lm	31 mm
SIRIUS HRI 280 W RO	CUSTOMIZED	280 W	11500 lm	34.5 mm
SIRIUS HRI 330 W X8	CUSTOMIZED	330 W	18000 lm	37.4 mm
SIRIUS HRI 371 W +	CORE	370 W	18300 lm	37.4 mm
SIRIUS HRI 295 W	CORE	295 W	11300 lm	34.5 mm
SIRIUS HRI 310 W	CORE	310 W	15000 lm	36.5 mm
SIRIUS HRI 310 W RO	CUSTOMIZED	310 W	13500 lm	48 mm
HRI 371 W S +	CORE	371 W	19800 lm	31.4 mm
SIRIUS HRI 371 W	VALUE	371 W	18300 lm	31.4 mm
SIRIUS HRI 310 W PRO	PRO	310 W	15500 lm	37.4 mm
SIRIUS HRI 371 W S	VALUE	371 W	19800 lm	37.4 mm
SIRIUS HRI 310 W S PRO	PRO	310 W	15500 lm	31.4 mm
SIRIUS HRI 440 W	CORE	440 W	22000 lm	41 mm
SIRIUS HRI 311 W	VALUE	311 W	14500 lm	31.4 mm
SIRIUS HRI 440 W H	CUSTOMIZED	440 W	18000 lm	60 mm
SIRIUS HRI 330 W XL	CORE	330 W	16500 lm	36 mm
SIRIUS HRI 471 W SN	VALUE	471 W	20000 lm	41 mm
SIRIUS HRI 550 W XL	CORE	550 W	28000 lm	59 mm
SIRIUS HRI 381 W S	CUSTOMIZED	381 W	20000 lm	34.4 mm
SIRIUS HRI 380 W Pro	PRO	380 W	20000 lm	31.4 mm
SIRIUS HRI 380 W S PRO	PRO	380 W	20000 lm	31.4 mm
SIRIUS HRI 382 W	CORE	382 W	21000 lm	37.4 mm
SIRIUS HRI 382 W S	CORE	382 W	20000 lm	31.4 mm
SIRIUS HRI 420 W	CORE	420 W	22000 lm	34.4 mm
SIRIUS HRI 420 W S	CORE	420 W	21000 lm	34.4 mm
SIRIUS HRI 440 W +	CORE	440 W	22800 lm	41 mm
SIRIUS HRI 440 W X	CUSTOMIZED	440 W	22800 lm	41 mm
SIRIUS HRI 461 W	VALUE	461 W	24000 lm	41 mm
SIRIUS HRI 461 W S	VALUE	461 W	24000 lm	37.4 mm
SIRIUS HRI 462 W	CORE	462 W	24000 lm	41 mm
SIRIUS HRI 470 W	CORE	470 W	20500 lm	41 mm
SIRIUS HRI 470 W S	CORE	470 W	21500 lm	37.4 mm

## Product family datasheet

Product description	General Product Information	Electrical Data	Photometric Data	
	Category	Nominal wattage	Nominal luminous flux	Working distance
SIRIUS HRI 470 W RO	CUSTOMIZED	470 W	19500 lm	48 mm
SIRIUS HRI 470 W XL	CORE	470 W	24000 lm	59 mm
SIRIUS HRI 550 W	CORE	550 W	28000 lm	41 mm
HRI 580 W F	CUSTOMIZED	580 W	29500 lm	60 mm

Product description	Physical Attributes & Dimensions			
	Electrode gap (cold)	Lamp base	Diameter	Length
SIRIUS HRI 100 W	1.0 mm	SPEZIAL	45.0 mm	53.0 mm
SIRIUS HRI 132 W SC	1.0 mm	-	46.0 mm	max. 44 mm
SIRIUS HRI 190 W+	-	-	51.0 mm	54.5 mm
SIRIUS HRI 230 W	1.0 mm	-	51.0 mm	54.5 mm
SIRIUS HRI 231 W	1.0 mm	-	51.0 mm	50.0 mm
SIRIUS HRI 280 W	0.9 mm	-	51.0 mm	54.5 mm
SIRIUS HRI 251 W	-	-	51.0 mm	61.0 mm
SIRIUS HRI 281 W	1.0 mm	-	51.0 mm	50.0 mm
SIRIUS HRI 260 W PRO	0.9 mm	-	51.0 mm	50.0 mm
SIRIUS HRI 330 W	1.0 mm	-	56.0 mm	63.0 mm
SIRIUS HRI 280 W RO	0.9 mm	-	51.0 mm	54.5 mm
SIRIUS HRI 330 W X8	1.0 mm	-	58.0 mm	66.0 mm
SIRIUS HRI 371 W +	1.2 mm	-	58.0 mm	72.0 mm
SIRIUS HRI 295 W	-	-	51.0 mm	53.5 mm
SIRIUS HRI 310 W	-	-	51.0 mm	53.5 mm
SIRIUS HRI 310 W RO	-	-	60.0 mm	67.0 mm
HRI 371 W S +	1.2 mm	-	58.0 mm	72.0 mm
SIRIUS HRI 371 W	1.0 mm	-	58.0 mm	72.0 mm
SIRIUS HRI 310 W PRO	0.9 mm	-	58.0 mm	72.0 mm
SIRIUS HRI 371 W S	1.2 mm	-	58.0 mm	72.0 mm
SIRIUS HRI 310 W S PRO	0.9 mm	-	58.0 mm	72.0 mm
SIRIUS HRI 440 W	1.3 mm	-	58.0 mm	71.0 mm
SIRIUS HRI 311 W	-	-	51.0 mm	50.0 mm
SIRIUS HRI 440 W H	1.3 mm	-	65.0 mm	60.0 mm
SIRIUS HRI 330 W XL	1.0 mm	-	56.0 mm	63.0 mm
SIRIUS HRI 471 W SN	1.3 mm	Side Prong	60.0 mm	67.0 mm
SIRIUS HRI 550 W XL	-	Side Prong	60.0 mm	67.0 mm
SIRIUS HRI 381 W S	-	-	58.0 mm	72.0 mm
SIRIUS HRI 380 W Pro	-	-	58.0 mm	72.0 mm
SIRIUS HRI 380 W S PRO	-	-	58.0 mm	72.0 mm
SIRIUS HRI 382 W	1.0 mm	-	58.0 mm	72.0 mm
SIRIUS HRI 382 W S	1.0 mm	-	58.0 mm	72.0 mm
SIRIUS HRI 420 W	-	-	58.0 mm	72.0 mm
SIRIUS HRI 420 W S	-	-	58.0 mm	72.0 mm
SIRIUS HRI 440 W +	-	-	58.0 mm	71.0 mm
SIRIUS HRI 440 W X	1.0 mm	-	58.0 mm	71.0 mm

## Product family datasheet

Product description	Physical Attributes & Dimensions			
	Electrode gap (cold)	Lamp base	Diameter	Length
SIRIUS HRI 461 W	1.3 mm	-	60.0 mm	67.0 mm
SIRIUS HRI 461 W S	1.3 mm	-	60.0 mm	67.0 mm
SIRIUS HRI 462 W		-	58.0 mm	72.0 mm
SIRIUS HRI 470 W	1.3 mm	-	58.0 mm	71.0 mm
SIRIUS HRI 470 W S	1.3 mm	-	58.0 mm	71.0 mm
SIRIUS HRI 470 W RO	1.2 mm	-	60.0 mm	67.0 mm
SIRIUS HRI 470 W XL	1.3 mm	-	60.0 mm	67.0 mm
SIRIUS HRI 550 W	1.5 mm	Side Prong	60.0 mm	67.0 mm
HRI 580 W F		-	65.0 mm	65.0 mm

Product description	Product weight	Diameter (in)	Connector: presence	Operating Conditions
				Burning position
SIRIUS HRI 100 W	60.00 g			Any
SIRIUS HRI 132 W SC	60.00 g	1.810 in		Any
SIRIUS HRI 190 W+	60.00 g			
SIRIUS HRI 230 W	60.00 g	2.008 in		Any
SIRIUS HRI 231 W	60.00 g			Any
SIRIUS HRI 280 W	60.00 g	2.008 in		Any
SIRIUS HRI 251 W	50.00 g			
SIRIUS HRI 281 W	60.00 g			Any
SIRIUS HRI 260 W PRO	60.00 g			
SIRIUS HRI 330 W	75.00 g	2.008 in		Any
SIRIUS HRI 280 W RO	65.00 g			Any
SIRIUS HRI 330 W X8	100.00 g	0.236 in		Any
SIRIUS HRI 371 W +	130.00 g			
SIRIUS HRI 295 W	63.50 g			
SIRIUS HRI 310 W	60.00 g			
SIRIUS HRI 310 W RO	135.00 g			Any
HRI 371 W S +	130.00 g			
SIRIUS HRI 371 W	130.00 g			Any
SIRIUS HRI 310 W PRO	130.00 g			
SIRIUS HRI 371 W S	130.00 g			Any
SIRIUS HRI 310 W S PRO	130.00 g			
SIRIUS HRI 440 W	100.00 g			Any
SIRIUS HRI 311 W	60.00 g			
SIRIUS HRI 440 W H	160.00 g			Any
SIRIUS HRI 330 W XL	75.00 g	0.512 in		Any
SIRIUS HRI 471 W SN	140.00 g			Any
SIRIUS HRI 550 W XL	140.00 g			
SIRIUS HRI 381 W S	130.00 g			
SIRIUS HRI 380 W Pro	130.00 g			
SIRIUS HRI 380 W S PRO	130.00 g			
SIRIUS HRI 382 W	136.00 g		Yes	
SIRIUS HRI 382 W S	136.00 g		Yes	

## Product family datasheet

Product description	Product weight	Diameter (in)	Connector: presence	Operating Conditions
				Burning position
SIRIUS HRI 420 W	130.00 g			
SIRIUS HRI 420 W S	130.00 g			
SIRIUS HRI 440 W +	135.50 g			
SIRIUS HRI 440 W X	135.50 g			
SIRIUS HRI 461 W	140.00 g			Any
SIRIUS HRI 461 W S	140.00 g			Any
SIRIUS HRI 462 W	130.00 g			
SIRIUS HRI 470 W	103.60 g			Any
SIRIUS HRI 470 W S	103.60 g			Any
SIRIUS HRI 470 W RO	140.00 g			Any
SIRIUS HRI 470 W XL	140.00 g			Any
SIRIUS HRI 550 W	140.00 g			
HRI 580 W F	160.00 g			

Product description	Cooling	Lifetime Data	Environmental & Regulatory Information Information according Art. 33 of EU Regulation (EC) 1907/2006 (REACH)	
		Nominal lifetime	Primary article identifier	Declaration no. in SCIP database
SIRIUS HRI 100 W	Forced	6000 hr	4052899329119   4052899321656	No declarable substances contained
SIRIUS HRI 132 W SC	Forced	6000 hr	4052899028708   4052899011335   4052899197404	No declarable substances contained
SIRIUS HRI 190 W+		3000 hr	4052899475397   4008321866592	No declarable substances contained
SIRIUS HRI 230 W	Forced	2500 hr	4008321810311	No declarable substances contained
SIRIUS HRI 231 W		2000 hr	4062172128681   4062172212311   4052899553521	No declarable substances contained
SIRIUS HRI 280 W	Forced	2000 hr	4008321810342	No declarable substances contained
SIRIUS HRI 251 W		3000 hr	4062172212458   4062172212434	No declarable substances contained
SIRIUS HRI 281 W		2000 hr	4052899553552   4062172128704	No declarable substances contained
SIRIUS HRI 260 W PRO		6000 hr	4062172118927   4062172118941	No declarable substances contained
SIRIUS HRI 330 W	Forced	1500 hr	4008321810373	No declarable substances contained
SIRIUS HRI 280 W RO		2000 hr	4052899110397	No declarable substances contained
SIRIUS HRI 330 W X8		1500 hr	4052899140325   4052899224346   4052899140295	No declarable substances contained
SIRIUS HRI 371 W +		3000 hr	4062172110327   4062172110341	No declarable substances contained



## Product family datasheet

Product description	Cooling	Lifetime Data	Environmental & Regulatory Information Information according Art. 33 of EU Regulation (EC) 1907/2006 (REACH)	
		Nominal lifetime	Primary article identifier	Declaration no. in SCIP database
SIRIUS HRI 295 W		2500 hr	4062172283328   4062172283304	No declarable substances contained
SIRIUS HRI 310 W		2500 hr	4062172202169   4062172202183	No declarable substances contained
SIRIUS HRI 310 W RO		3000 hr	4062172140867   4062172140843	No declarable substances contained
HRI 371 W S +		3000 hr	4062172110372   4062172110396	No declarable substances contained
SIRIUS HRI 371 W		1500 hr	4062172057004   4062172056984	No declarable substances contained
SIRIUS HRI 310 W PRO		1500 hr	4062172169424   4062172085304	No declarable substances contained
SIRIUS HRI 371 W S		1500 hr	4062172056939   4062172056953	No declarable substances contained
SIRIUS HRI 310 W S PRO		1500 hr	4062172169455   4062172122825	No declarable substances contained
SIRIUS HRI 440 W	Forced	1500 hr	4052899259096   4052899222212   4052899587892   4052899570566   4052899553644	No declarable substances contained
SIRIUS HRI 311 W		2500 hr	4062172169363	No declarable substances contained
SIRIUS HRI 440 W H		1000 hr	4052899576735	No declarable substances contained
SIRIUS HRI 330 W XL		1500 hr	4052899195431	No declarable substances contained
SIRIUS HRI 471 W SN		1500 hr	4062172040358	No declarable substances contained
SIRIUS HRI 550 W XL		1000 hr	4062172168212   4062172168236	No declarable substances contained
SIRIUS HRI 381 W S		2500 hr	4062172226240   4062172226226	No declarable substances contained
SIRIUS HRI 380 W Pro		2500 hr	4062172168601   4062172168625	No declarable substances contained
SIRIUS HRI 380 W S PRO		2500 hr	4062172168311   4062172168335	No declarable substances contained
SIRIUS HRI 382 W		2500 hr	4062172047135   4062172326131	No declarable substances contained
SIRIUS HRI 382 W S		1500 hr	4062172033541   4062172326100	No declarable substances contained
SIRIUS HRI 420 W		2500 hr	4062172192750   4062172192736	No declarable substances contained

## Product family datasheet

Product description	Cooling	Lifetime Data	Environmental & Regulatory Information Information according Art. 33 of EU Regulation (EC) 1907/2006 (REACH)	
		Nominal lifetime	Primary article identifier	Declaration no. in SCIP database
SIRIUS HRI 420 W S		2500 hr	4062172192682   4062172392938   4062172393225   4062172192705   4062172392891   4062172393201	No declarable substances contained
SIRIUS HRI 440 W +		1500 hr	4062172348874   4062172047333	No declarable substances contained
SIRIUS HRI 440 W X		1500 hr	4062172017442	No declarable substances contained
SIRIUS HRI 461 W		1500 hr	4052899553613	No declarable substances contained
SIRIUS HRI 461 W S		1500 hr	4052899553583	No declarable substances contained
SIRIUS HRI 462 W		2000 hr	4062172302128   4062172302104	No declarable substances contained
SIRIUS HRI 470 W		1500 hr	4062172169332   4052899580961	No declarable substances contained
SIRIUS HRI 470 W S		1500 hr	4052899580985   4062172169301	No declarable substances contained
SIRIUS HRI 470 W RO		1500 hr	4052899477018	No declarable substances contained
SIRIUS HRI 470 W XL		1500 hr	4062172017473   4062172168281	No declarable substances contained
SIRIUS HRI 550 W		1500 hr	4062172008761   4062172078122	No declarable substances contained
HRI 580 W F		1000 hr	4062172085267	No declarable substances contained

Product description	Candidate list substance 1
SIRIUS HRI 100 W	No declarable substances contained
SIRIUS HRI 132 W SC	No declarable substances contained
SIRIUS HRI 190 W+	No declarable substances contained
SIRIUS HRI 230 W	No declarable substances contained
SIRIUS HRI 231 W	No declarable substances contained
SIRIUS HRI 280 W	No declarable substances contained
SIRIUS HRI 251 W	No declarable substances contained
SIRIUS HRI 281 W	No declarable substances contained

## Product family datasheet

Product description	Candidate list substance 1
SIRIUS HRI 260 W PRO	No declarable substances contained
SIRIUS HRI 330 W	No declarable substances contained
SIRIUS HRI 280 W RO	No declarable substances contained
SIRIUS HRI 330 W X8	No declarable substances contained
SIRIUS HRI 371 W +	No declarable substances contained
SIRIUS HRI 295 W	No declarable substances contained
SIRIUS HRI 310 W	No declarable substances contained
SIRIUS HRI 310 W RO	No declarable substances contained
HRI 371 W S +	No declarable substances contained
SIRIUS HRI 371 W	No declarable substances contained
SIRIUS HRI 310 W PRO	No declarable substances contained
SIRIUS HRI 371 W S	No declarable substances contained
SIRIUS HRI 310 W S PRO	No declarable substances contained
SIRIUS HRI 440 W	No declarable substances contained
SIRIUS HRI 311 W	No declarable substances contained
SIRIUS HRI 440 W H	No declarable substances contained
SIRIUS HRI 330 W XL	No declarable substances contained
SIRIUS HRI 471 W SN	No declarable substances contained
SIRIUS HRI 550 W XL	No declarable substances contained
SIRIUS HRI 381 W S	No declarable substances contained
SIRIUS HRI 380 W Pro	No declarable substances contained
SIRIUS HRI 380 W S PRO	No declarable substances contained
SIRIUS HRI 382 W	No declarable substances contained
SIRIUS HRI 382 W S	No declarable substances contained

## Product family datasheet

<b>Product description</b>	<b>Candidate list substance 1</b>
SIRIUS HRI 420 W	No declarable substances contained
SIRIUS HRI 420 W S	No declarable substances contained
SIRIUS HRI 440 W +	No declarable substances contained
SIRIUS HRI 440 W X	No declarable substances contained
SIRIUS HRI 461 W	No declarable substances contained
SIRIUS HRI 461 W S	No declarable substances contained
SIRIUS HRI 462 W	No declarable substances contained
SIRIUS HRI 470 W	No declarable substances contained
SIRIUS HRI 470 W S	No declarable substances contained
SIRIUS HRI 470 W RO	No declarable substances contained
SIRIUS HRI 470 W XL	No declarable substances contained
SIRIUS HRI 550 W	No declarable substances contained
HRI 580 W F	No declarable substances contained

## Product family datasheet

---

### Safety advice

Because of their high luminance, UV radiation and high internal pressure during operation, SIRIUS HRI lamps may only be operated in enclosed lamp casings specially constructed for the purpose. Appropriate filters must ensure that UV radiation is reduced to an acceptable level. Mercury is released if the lamp breaks. Special safety precautions must be taken. Information on safety and handling is available on request or can be found in the leaflet included with the lamp or in the operating instructions.

---

### Application advice

For more detailed application information and graphics please see product datasheet.

---

### Disclaimer

Subject to change without notice. Errors and omission excepted. Always make sure to use the most recent release.