

SIRIUS HRI

High pressure discharge lamps designed to provide brilliant light effects.



Areas of application

- Concert Lighting
- Club & Disco
- Stage & Theatre
- Studio, TV, & Film
- Architecture & Architainment

Product features and benefits

- Lightweight and compact reflector lamps with ECG
- High luminance through very short arc and high pressure
- Produces brilliant light effects
- Stable light output over the entire lifetime
- Long lifetime
- Easy lamp replacement
- Approved by leading moving lighting fixture companies



Product family datasheet

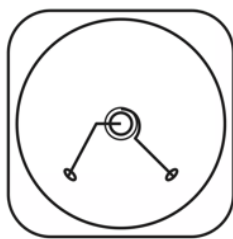
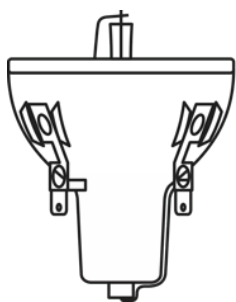

SIRIUS HRI 100W

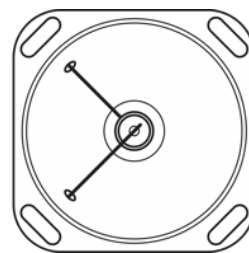
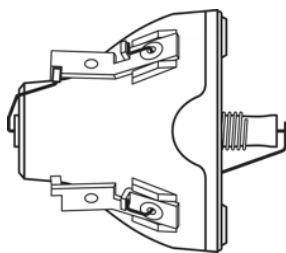

SIRIUS HRI 132W

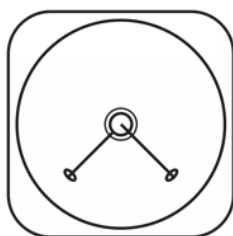
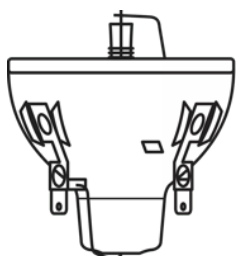

SIRIUS HRI 132W

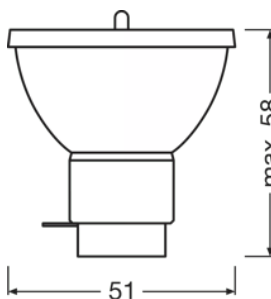

SIRIUS HRI 251W

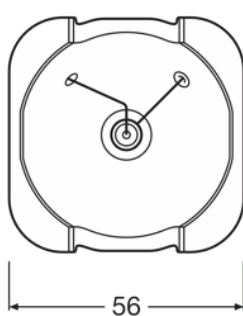
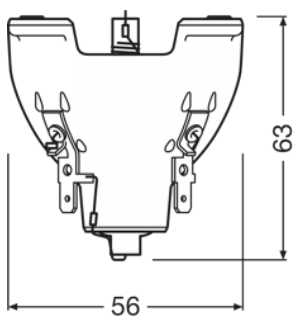

SIRIUS HRI 330W

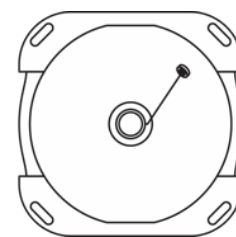
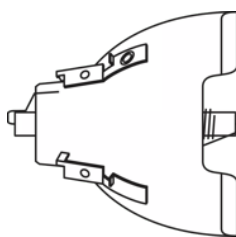

SIRIUS HRI 330W

Product family datasheet

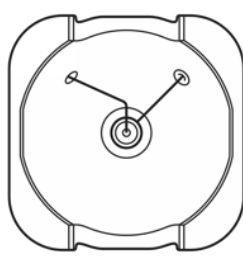
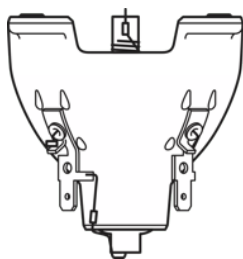

SIRIUS HRI 330W

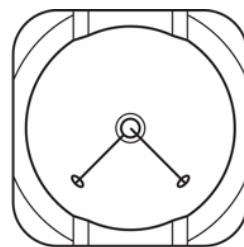
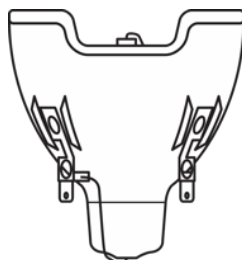

SIRIUS HRI 330W X8

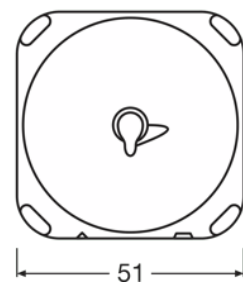
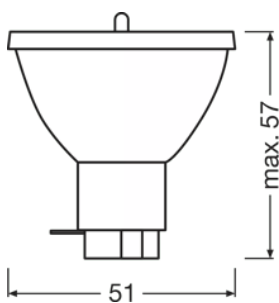

SIRIUS HRI 295 W

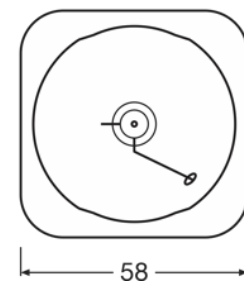
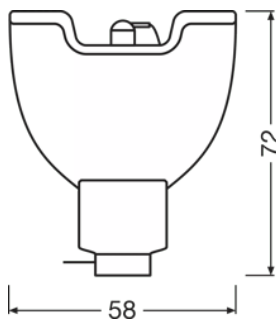

SIRIUS HRI 371W

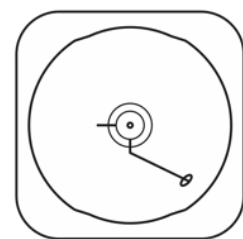
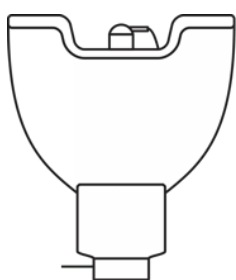

SIRIUS HRI 371W

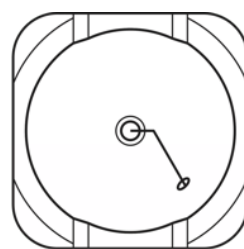
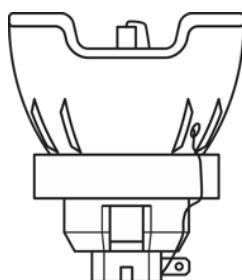

SIRIUS HRI 440W

Product family datasheet

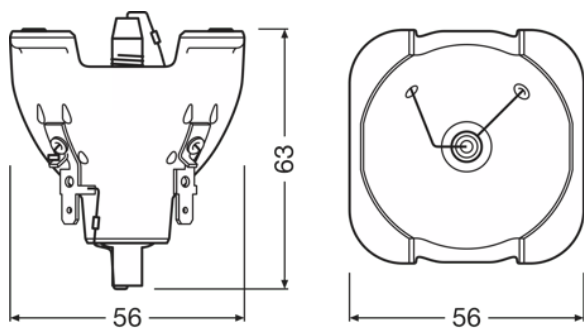

Sirius HRI 330W XL

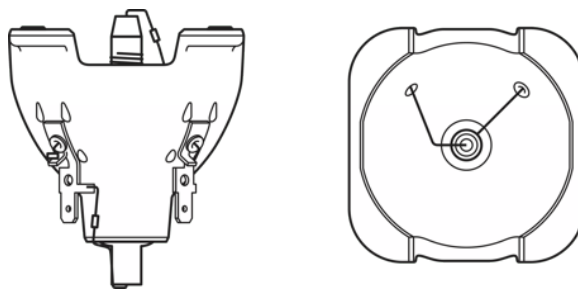

Sirius HRI 330W XL

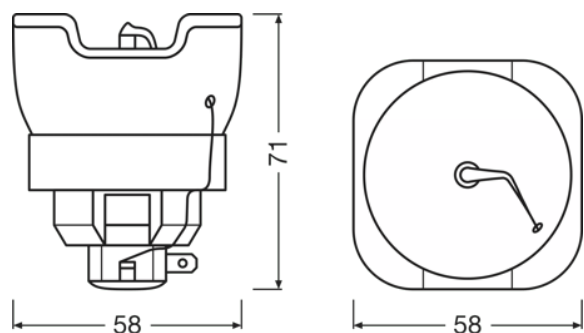

SIRIUS HRI 580 F

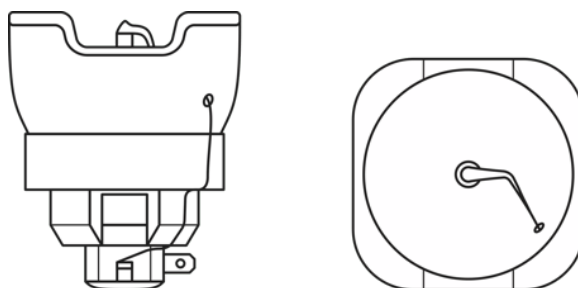

SIRIUS HRI 580 F

Product family datasheet

Technical data

| Product description | General Product Information | Electrical Data | Photometric Data | |
|------------------------|-----------------------------|-----------------|-----------------------|------------------|
| | Category | Nominal wattage | Nominal luminous flux | Working distance |
| SIRIUS HRI 100 W | CORE | 100 W | 3680 lm | 30 mm |
| SIRIUS HRI 132 W SC | CORE | 132 W | 5150 lm | 37.7 mm |
| SIRIUS HRI 140 W RO | CUSTOMIZED | 140 W | 5400 lm | 37.7 mm |
| SIRIUS HRI 190 W+ | CORE | 190 W | 8100 lm | 34.5 mm |
| SIRIUS HRI 230 W | CORE | 230 W | 9500 lm | 34.5 mm |
| SIRIUS HRI 231 W | VALUE | 231 W | 10800 lm | 34.5 mm |
| SIRIUS HRI 280 W | CORE | 280 W | 11500 lm | 34.5 mm |
| SIRIUS HRI 251 W | VALUE | 251 W | 12000 lm | 38 mm |
| SIRIUS HRI 281 W | VALUE | 281 W | 13000 lm | 34.5 mm |
| SIRIUS HRI 260 W PRO | PRO | 260 W | 13500 lm | 34.5 mm |
| SIRIUS HRI 330 W | CORE | 330 W | 18000 lm | 31 mm |
| SIRIUS HRI 280 W RO | CUSTOMIZED | 280 W | 11500 lm | 34.5 mm |
| SIRIUS HRI 330 W X8 | CUSTOMIZED | 330 W | 18000 lm | 37.4 mm |
| SIRIUS HRI 371 W + | CORE | 370 W | 18300 lm | 37.4 mm |
| SIRIUS HRI 295 W | CORE | 295 W | 11300 lm | 34.5 mm |
| SIRIUS HRI 310 W | CORE | 310 W | 15000 lm | 36.5 mm |
| SIRIUS HRI 310 W RO | CUSTOMIZED | 310 W | 13500 lm | 48 mm |
| HRI 371 W S + | CORE | 371 W | 19800 lm | 31.4 mm |
| SIRIUS HRI 371 W | VALUE | 371 W | 18300 lm | 31.4 mm |
| SIRIUS HRI 310 W PRO | PRO | 310 W | 15500 lm | 37.4 mm |
| SIRIUS HRI 371 W S | VALUE | 371 W | 19800 lm | 37.4 mm |
| SIRIUS HRI 310 W S PRO | PRO | 310 W | 15500 lm | 31.4 mm |
| SIRIUS HRI 440 W | CORE | 440 W | 22000 lm | 41 mm |
| SIRIUS HRI 311 W | VALUE | 311 W | 14500 lm | 31.4 mm |
| SIRIUS HRI 440 W H | CUSTOMIZED | 440 W | 18000 lm | 60 mm |
| SIRIUS HRI 330 W XL | CORE | 330 W | 16500 lm | 36 mm |
| SIRIUS HRI 471 W SN | VALUE | 471 W | 20000 lm | 41 mm |
| SIRIUS HRI 550 W XL | CORE | 550 W | 28000 lm | 59 mm |
| SIRIUS HRI 381 W S | CUSTOMIZED | 381 W | 20000 lm | 34.4 mm |
| SIRIUS HRI 380 W Pro | PRO | 380 W | 20000 lm | 31.4 mm |
| SIRIUS HRI 380 W S PRO | PRO | 380 W | 20000 lm | 31.4 mm |
| SIRIUS HRI 382 W | CORE | 382 W | 21000 lm | 37.4 mm |
| SIRIUS HRI 382 W S | CORE | 382 W | 20000 lm | 31.4 mm |
| SIRIUS HRI 420 W | CORE | 420 W | 22000 lm | 34.4 mm |
| SIRIUS HRI 420 W S | CORE | 420 W | 21000 lm | 34.4 mm |
| SIRIUS HRI 440 W + | CORE | 440 W | 22800 lm | 41 mm |
| SIRIUS HRI 440 W S | CORE | 440 W | 22800 lm | 37.4 mm |
| SIRIUS HRI 440 W X | CUSTOMIZED | 440 W | 22800 lm | 41 mm |
| SIRIUS HRI 461 W | VALUE | 461 W | 24000 lm | 41 mm |
| SIRIUS HRI 461 W S | VALUE | 461 W | 24000 lm | 37.4 mm |
| SIRIUS HRI 462 W | CORE | 462 W | 24000 lm | 41 mm |

Product family datasheet

| Product description | General Product Information | Electrical Data | Photometric Data | |
|---------------------|-----------------------------|-----------------|-----------------------|------------------|
| | Category | Nominal wattage | Nominal luminous flux | Working distance |
| SIRIUS HRI 470 W | CORE | 470 W | 20500 lm | 41 mm |
| SIRIUS HRI 470 W S | CORE | 470 W | 21500 lm | 37.4 mm |
| SIRIUS HRI 470 W RO | CUSTOMIZED | 470 W | 19500 lm | 48 mm |
| SIRIUS HRI 470 W XL | CORE | 470 W | 24000 lm | 59 mm |
| SIRIUS HRI 550 W | CORE | 550 W | 28000 lm | 41 mm |
| HRI 580 W F | CUSTOMIZED | 580 W | 29500 lm | 60 mm |

| Product description | Physical Attributes & Dimensions | | | |
|------------------------|----------------------------------|------------|----------|------------|
| | Electrode gap (cold) | Lamp base | Diameter | Length |
| SIRIUS HRI 100 W | 1.0 mm | SPEZIAL | 45.0 mm | 53.0 mm |
| SIRIUS HRI 132 W SC | 1.0 mm | - | 46.0 mm | max. 44 mm |
| SIRIUS HRI 140 W RO | 1.0 mm | - | 46.0 mm | max. 44 mm |
| SIRIUS HRI 190 W+ | - | - | 51.0 mm | 54.5 mm |
| SIRIUS HRI 230 W | 1.0 mm | - | 51.0 mm | 54.5 mm |
| SIRIUS HRI 231 W | 1.0 mm | - | 51.0 mm | 50.0 mm |
| SIRIUS HRI 280 W | 0.9 mm | - | 51.0 mm | 54.5 mm |
| SIRIUS HRI 251 W | - | - | 51.0 mm | 61.0 mm |
| SIRIUS HRI 281 W | 1.0 mm | - | 51.0 mm | 50.0 mm |
| SIRIUS HRI 260 W PRO | 0.9 mm | - | 51.0 mm | 50.0 mm |
| SIRIUS HRI 330 W | 1.0 mm | - | 56.0 mm | 63.0 mm |
| SIRIUS HRI 280 W RO | 0.9 mm | - | 51.0 mm | 54.5 mm |
| SIRIUS HRI 330 W X8 | 1.0 mm | - | 58.0 mm | 66.0 mm |
| SIRIUS HRI 371 W + | 1.2 mm | - | 58.0 mm | 72.0 mm |
| SIRIUS HRI 295 W | - | - | 51.0 mm | 53.5 mm |
| SIRIUS HRI 310 W | - | - | 51.0 mm | 53.5 mm |
| SIRIUS HRI 310 W RO | - | - | 60.0 mm | 67.0 mm |
| HRI 371 W S + | 1.2 mm | - | 58.0 mm | 72.0 mm |
| SIRIUS HRI 371 W | 1.0 mm | - | 58.0 mm | 72.0 mm |
| SIRIUS HRI 310 W PRO | 0.9 mm | - | 58.0 mm | 72.0 mm |
| SIRIUS HRI 371 W S | 1.2 mm | - | 58.0 mm | 72.0 mm |
| SIRIUS HRI 310 W S PRO | 0.9 mm | - | 58.0 mm | 72.0 mm |
| SIRIUS HRI 440 W | 1.3 mm | - | 58.0 mm | 71.0 mm |
| SIRIUS HRI 311 W | - | - | 51.0 mm | 50.0 mm |
| SIRIUS HRI 440 W H | 1.3 mm | - | 65.0 mm | 60.0 mm |
| SIRIUS HRI 330 W XL | 1.0 mm | - | 56.0 mm | 63.0 mm |
| SIRIUS HRI 471 W SN | 1.3 mm | Side Prong | 60.0 mm | 67.0 mm |
| SIRIUS HRI 550 W XL | - | Side Prong | 60.0 mm | 67.0 mm |
| SIRIUS HRI 381 W S | - | - | 58.0 mm | 72.0 mm |
| SIRIUS HRI 380 W Pro | - | - | 58.0 mm | 72.0 mm |
| SIRIUS HRI 380 W S PRO | - | - | 58.0 mm | 72.0 mm |
| SIRIUS HRI 382 W | 1.0 mm | - | 58.0 mm | 72.0 mm |
| SIRIUS HRI 382 W S | 1.0 mm | - | 58.0 mm | 72.0 mm |
| SIRIUS HRI 420 W | - | - | 58.0 mm | 72.0 mm |

Product family datasheet

| Product description | Physical Attributes & Dimensions | | | |
|---------------------|----------------------------------|------------|----------|---------|
| | Electrode gap (cold) | Lamp base | Diameter | Length |
| SIRIUS HRI 420 W S | | - | 58.0 mm | 72.0 mm |
| SIRIUS HRI 440 W + | | - | 58.0 mm | 71.0 mm |
| SIRIUS HRI 440 W S | | - | 11.8 mm | 71.0 mm |
| SIRIUS HRI 440 W X | 1.0 mm | - | 58.0 mm | 71.0 mm |
| SIRIUS HRI 461 W | 1.3 mm | - | 60.0 mm | 67.0 mm |
| SIRIUS HRI 461 W S | 1.3 mm | - | 60.0 mm | 67.0 mm |
| SIRIUS HRI 462 W | | - | 58.0 mm | 72.0 mm |
| SIRIUS HRI 470 W | 1.3 mm | - | 58.0 mm | 71.0 mm |
| SIRIUS HRI 470 W S | 1.3 mm | - | 58.0 mm | 71.0 mm |
| SIRIUS HRI 470 W RO | 1.2 mm | - | 60.0 mm | 67.0 mm |
| SIRIUS HRI 470 W XL | 1.3 mm | - | 60.0 mm | 67.0 mm |
| SIRIUS HRI 550 W | 1.5 mm | Side Prong | 60.0 mm | 67.0 mm |
| HRI 580 W F | | - | 65.0 mm | 65.0 mm |

| Product description | Product weight | Diameter (in) | Connector: presence | Operating Conditions |
|------------------------|----------------|---------------|---------------------|----------------------|
| | | | | Burning position |
| SIRIUS HRI 100 W | 60.00 g | | | Any |
| SIRIUS HRI 132 W SC | 60.00 g | 1.810 in | | Any |
| SIRIUS HRI 140 W RO | 60.00 g | | | Any |
| SIRIUS HRI 190 W+ | 60.00 g | | | |
| SIRIUS HRI 230 W | 60.00 g | 2.008 in | | Any |
| SIRIUS HRI 231 W | 60.00 g | | | Any |
| SIRIUS HRI 280 W | 60.00 g | 2.008 in | | Any |
| SIRIUS HRI 251 W | 50.00 g | | | |
| SIRIUS HRI 281 W | 60.00 g | | | Any |
| SIRIUS HRI 260 W PRO | 60.00 g | | | |
| SIRIUS HRI 330 W | 75.00 g | 2.008 in | | Any |
| SIRIUS HRI 280 W RO | 65.00 g | | | Any |
| SIRIUS HRI 330 W X8 | 100.00 g | 0.236 in | | Any |
| SIRIUS HRI 371 W + | 130.00 g | | | |
| SIRIUS HRI 295 W | 63.50 g | | | |
| SIRIUS HRI 310 W | 60.00 g | | | |
| SIRIUS HRI 310 W RO | 135.00 g | | | Any |
| HRI 371 W S + | 130.00 g | | | |
| SIRIUS HRI 371 W | 130.00 g | | | Any |
| SIRIUS HRI 310 W PRO | 130.00 g | | | |
| SIRIUS HRI 371 W S | 130.00 g | | | Any |
| SIRIUS HRI 310 W S PRO | 130.00 g | | | |
| SIRIUS HRI 440 W | 100.00 g | | | Any |
| SIRIUS HRI 311 W | 60.00 g | | | |
| SIRIUS HRI 440 W H | 160.00 g | | | Any |
| SIRIUS HRI 330 W XL | 75.00 g | 0.512 in | | Any |
| SIRIUS HRI 471 W SN | 140.00 g | | | Any |
| SIRIUS HRI 550 W XL | 140.00 g | | | |

Product family datasheet

| Product description | Product weight | Diameter (in) | Connector: presence | Operating Conditions |
|------------------------|----------------|---------------|---------------------|----------------------|
| | | | | Burning position |
| SIRIUS HRI 381 W S | 130.00 g | | | |
| SIRIUS HRI 380 W Pro | 130.00 g | | | |
| SIRIUS HRI 380 W S PRO | 130.00 g | | | |
| SIRIUS HRI 382 W | 136.00 g | | Yes | |
| SIRIUS HRI 382 W S | 136.00 g | | Yes | |
| SIRIUS HRI 420 W | 130.00 g | | | |
| SIRIUS HRI 420 W S | 130.00 g | | | |
| SIRIUS HRI 440 W + | 135.50 g | | | |
| SIRIUS HRI 440 W S | 100.00 g | | | Any |
| SIRIUS HRI 440 W X | 135.50 g | | | |
| SIRIUS HRI 461 W | 140.00 g | | | Any |
| SIRIUS HRI 461 W S | 140.00 g | | | Any |
| SIRIUS HRI 462 W | 130.00 g | | | |
| SIRIUS HRI 470 W | 103.60 g | | | Any |
| SIRIUS HRI 470 W S | 103.60 g | | | Any |
| SIRIUS HRI 470 W RO | 140.00 g | | | Any |
| SIRIUS HRI 470 W XL | 140.00 g | | | Any |
| SIRIUS HRI 550 W | 140.00 g | | | |
| HRI 580 W F | 160.00 g | | | |

| Product description | Cooling | Lifetime Data | Environmental & Regulatory Information Information according Art. 33 of EU Regulation (EC) 1907/2006 (REACH) | |
|----------------------|---------|------------------|--|---------------------------------------|
| | | Nominal lifetime | Primary article identifier | Declaration no. in SCIP database |
| SIRIUS HRI 100 W | Forced | 6000 hr | 4052899329119 4052899321656 | No declarable substances contained |
| SIRIUS HRI 132 W SC | Forced | 6000 hr | 4052899028708 4052899011335 4052899197404 | No declarable substances contained |
| SIRIUS HRI 140 W RO | Forced | 6000 hr | 4052899258969 4052899224056 | No declarable substances contained |
| SIRIUS HRI 190 W+ | | 3000 hr | 4052899475397 4008321866592 | No declarable substances contained |
| SIRIUS HRI 230 W | Forced | 2500 hr | 4008321810311 | No declarable substances contained |
| SIRIUS HRI 231 W | | 2000 hr | 4062172128681 4062172212311 4052899553521 | No declarable substances contained |
| SIRIUS HRI 280 W | Forced | 2000 hr | 4008321810342 | No declarable substances contained |
| SIRIUS HRI 251 W | | 3000 hr | 4062172212458 4062172212434 | No declarable substances contained |
| SIRIUS HRI 281 W | | 2000 hr | 4052899553552 4062172128704 | No declarable substances contained |
| SIRIUS HRI 260 W PRO | | 6000 hr | 4062172118927 4062172118941 | No declarable substances contained |

Product family datasheet

| Product description | Cooling | Lifetime Data | Environmental & Regulatory Information Information according Art. 33 of EU Regulation (EC) 1907/2006 (REACH) | |
|------------------------|---------|------------------|--|---------------------------------------|
| | | Nominal lifetime | Primary article identifier | Declaration no. in SCIP database |
| SIRIUS HRI 330 W | Forced | 1500 hr | 4008321810373 | No declarable substances contained |
| SIRIUS HRI 280 W RO | | 2000 hr | 4052899110397 | No declarable substances contained |
| SIRIUS HRI 330 W X8 | | 1500 hr | 4052899140325 4052899224346 4052899140295 | No declarable substances contained |
| SIRIUS HRI 371 W + | | 3000 hr | 4062172110327 4062172110341 | No declarable substances contained |
| SIRIUS HRI 295 W | | 2500 hr | 4062172283328 4062172283304 | No declarable substances contained |
| SIRIUS HRI 310 W | | 2500 hr | 4062172202169 4062172202183 | No declarable substances contained |
| SIRIUS HRI 310 W RO | | 3000 hr | 4062172140867 4062172140843 | No declarable substances contained |
| HRI 371 W S + | | 3000 hr | 4062172110372 4062172110396 | No declarable substances contained |
| SIRIUS HRI 371 W | | 1500 hr | 4062172057004 4062172056984 | No declarable substances contained |
| SIRIUS HRI 310 W PRO | | 1500 hr | 4062172169424 4062172085304 | No declarable substances contained |
| SIRIUS HRI 371 W S | | 1500 hr | 4062172056939 4062172056953 | No declarable substances contained |
| SIRIUS HRI 310 W S PRO | | 1500 hr | 4062172169455 4062172122825 | No declarable substances contained |
| SIRIUS HRI 440 W | Forced | 1500 hr | 4052899259096 4052899222212 4052899587892 4052899570566 4052899553644 | No declarable substances contained |
| SIRIUS HRI 311 W | | 2500 hr | 4062172169363 | No declarable substances contained |
| SIRIUS HRI 440 W H | | 1000 hr | 4052899576735 | No declarable substances contained |
| SIRIUS HRI 330 W XL | | 1500 hr | 4052899195431 | No declarable substances contained |
| SIRIUS HRI 471 W SN | | 1500 hr | 4062172040358 | No declarable substances contained |
| SIRIUS HRI 550 W XL | | 1000 hr | 4062172168212 4062172168236 | No declarable substances contained |
| SIRIUS HRI 381 W S | | 2500 hr | 4062172226240 4062172226226 | No declarable substances contained |
| SIRIUS HRI 380 W Pro | | 2500 hr | 4062172168601 4062172168625 | No declarable substances contained |
| SIRIUS HRI 380 W S PRO | | 2500 hr | 4062172168311 4062172168335 | No declarable substances contained |
| SIRIUS HRI 382 W | | 2500 hr | 4062172047135 4062172326131 | No declarable substances contained |

Product family datasheet

| Product description | Cooling | Lifetime Data | Environmental & Regulatory Information Information according Art. 33 of EU Regulation (EC) 1907/2006 (REACH) | |
|---------------------|---------|------------------|--|---------------------------------------|
| | | Nominal lifetime | Primary article identifier | Declaration no. in SCIP database |
| SIRIUS HRI 382 W S | | 1500 hr | 4062172033541 4062172326100 | No declarable substances contained |
| SIRIUS HRI 420 W | | 2500 hr | 4062172192750 4062172192736 | No declarable substances contained |
| SIRIUS HRI 420 W S | | 2500 hr | 4062172192682 4062172392938 4062172393225 4062172192705 4062172392891 4062172393201 | No declarable substances contained |
| SIRIUS HRI 440 W + | | 1500 hr | 4062172348874 4062172047333 | No declarable substances contained |
| SIRIUS HRI 440 W S | | 1000 hr | 4052899329140 | No declarable substances contained |
| SIRIUS HRI 440 W X | | 1500 hr | 4062172017442 | No declarable substances contained |
| SIRIUS HRI 461 W | | 1500 hr | 4052899553613 | No declarable substances contained |
| SIRIUS HRI 461 W S | | 1500 hr | 4052899553583 | No declarable substances contained |
| SIRIUS HRI 462 W | | 2000 hr | 4062172302128 4062172302104 | No declarable substances contained |
| SIRIUS HRI 470 W | | 1500 hr | 4062172169332 4052899580961 | No declarable substances contained |
| SIRIUS HRI 470 W S | | 1500 hr | 4052899580985 4062172169301 | No declarable substances contained |
| SIRIUS HRI 470 W RO | | 1500 hr | 4052899477018 | No declarable substances contained |
| SIRIUS HRI 470 W XL | | 1500 hr | 4062172017473 4062172168281 | No declarable substances contained |
| SIRIUS HRI 550 W | | 1500 hr | 4062172008761 4062172078122 | No declarable substances contained |
| HRI 580 W F | | 1000 hr | 4062172085267 | No declarable substances contained |

| Product description | Candidate list substance 1 |
|---------------------|---------------------------------------|
| SIRIUS HRI 100 W | No declarable substances contained |
| SIRIUS HRI 132 W SC | No declarable substances contained |
| SIRIUS HRI 140 W RO | No declarable substances contained |
| SIRIUS HRI 190 W+ | No declarable substances contained |
| SIRIUS HRI 230 W | No declarable substances contained |

Product family datasheet

| Product description | Candidate list substance 1 |
|------------------------|------------------------------------|
| SIRIUS HRI 231 W | No declarable substances contained |
| SIRIUS HRI 280 W | No declarable substances contained |
| SIRIUS HRI 251 W | No declarable substances contained |
| SIRIUS HRI 281 W | No declarable substances contained |
| SIRIUS HRI 260 W PRO | No declarable substances contained |
| SIRIUS HRI 330 W | No declarable substances contained |
| SIRIUS HRI 280 W RO | No declarable substances contained |
| SIRIUS HRI 330 W X8 | No declarable substances contained |
| SIRIUS HRI 371 W + | No declarable substances contained |
| SIRIUS HRI 295 W | No declarable substances contained |
| SIRIUS HRI 310 W | No declarable substances contained |
| SIRIUS HRI 310 W RO | No declarable substances contained |
| HRI 371 W S + | No declarable substances contained |
| SIRIUS HRI 371 W | No declarable substances contained |
| SIRIUS HRI 310 W PRO | No declarable substances contained |
| SIRIUS HRI 371 W S | No declarable substances contained |
| SIRIUS HRI 310 W S PRO | No declarable substances contained |
| SIRIUS HRI 440 W | No declarable substances contained |
| SIRIUS HRI 311 W | No declarable substances contained |
| SIRIUS HRI 440 W H | No declarable substances contained |
| SIRIUS HRI 330 W XL | No declarable substances contained |
| SIRIUS HRI 471 W SN | No declarable substances contained |
| SIRIUS HRI 550 W XL | No declarable substances contained |
| SIRIUS HRI 381 W S | No declarable substances contained |

Product family datasheet

| Product description | Candidate list substance 1 |
|------------------------|------------------------------------|
| SIRIUS HRI 380 W Pro | No declarable substances contained |
| SIRIUS HRI 380 W S PRO | No declarable substances contained |
| SIRIUS HRI 382 W | No declarable substances contained |
| SIRIUS HRI 382 W S | No declarable substances contained |
| SIRIUS HRI 420 W | No declarable substances contained |
| SIRIUS HRI 420 W S | No declarable substances contained |
| SIRIUS HRI 440 W + | No declarable substances contained |
| SIRIUS HRI 440 W S | No declarable substances contained |
| SIRIUS HRI 440 W X | No declarable substances contained |
| SIRIUS HRI 461 W | No declarable substances contained |
| SIRIUS HRI 461 W S | No declarable substances contained |
| SIRIUS HRI 462 W | No declarable substances contained |
| SIRIUS HRI 470 W | No declarable substances contained |
| SIRIUS HRI 470 W S | No declarable substances contained |
| SIRIUS HRI 470 W RO | No declarable substances contained |
| SIRIUS HRI 470 W XL | No declarable substances contained |
| SIRIUS HRI 550 W | No declarable substances contained |
| HRI 580 W F | No declarable substances contained |

Product family datasheet

Safety advice

Because of their high luminance, UV radiation and high internal pressure during operation, SIRIUS HRI lamps may only be operated in enclosed lamp casings specially constructed for the purpose. Appropriate filters must ensure that UV radiation is reduced to an acceptable level. Mercury is released if the lamp breaks. Special safety precautions must be taken. Information on safety and handling is available on request or can be found in the leaflet included with the lamp or in the operating instructions.

Application advice

For more detailed application information and graphics please see product datasheet.

Disclaimer

Subject to change without notice. Errors and omission excepted. Always make sure to use the most recent release.