

# LEDguardian TRUCK FLARE Signal TA19

LEDguardian warning- and safety lights

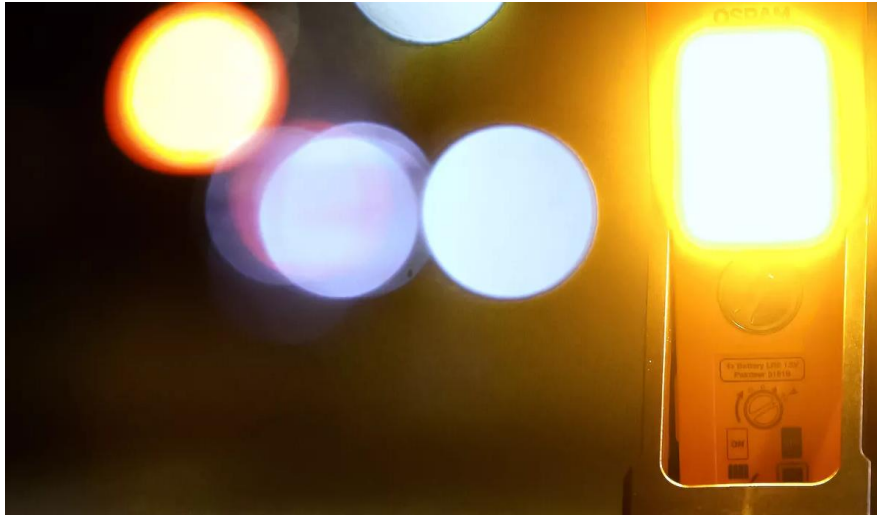

### Street legal in Germany

Carrying along in the vehicle and positioning of a warning light in the event of a broken-down vehicle is mandatory in Germany for all vehicles  $\geq 3.5t$  in accordance with §53a TA19 StVZO



### 2 in 1

LED Warning Light & LED Torchlight  
Bright yellow flashing light & Bright white torchlight



### 4x AA batteries included

Thanks to the included batteries, the warning light is ready for use immediately after purchase



### 2-year-OSRAM guarantee\*

Systematic quality assurance measures underpin the premium workmanship and functionality of our products. Innovative technology and excellent quality really pay dividends for our customers.

## Product datasheet



### Light is safety-See and be seen with OSRAM

Be prepared - with OSRAM LEDguardian warning and safety lights. The OSRAM LEDguardian TRUCK FLARE Signal TA19 is a LED warning light which must be carried along in the vehicle and used in the event of a break-down in Germany. This applies to all vehicles with a total weight of  $\geq 3.5t$  according to §53a StVZO. In addition, the TRUCK FLARE from OSRAM also meets the requirements specified in the technical requirements of the StVZO (TA 19). These state that the warning light must fulfill the following characteristics: An orange flashing light, an uninterrupted operating time of at least 15h, a flashing frequency of  $1.5 \text{ Hz} \pm 0.5 \text{ Hz} \pm 90 \pm$  pulses per minute and a dynamic pressure  $21 \text{ kg/m}^2 \pm$  wind force 9. Only those lights that meet these requirements are officially approved for use in road traffic. The warning light must be in operation next to the warning triangle to indicate the danger zone in the event of a breakdown or accident. For vehicles  $\leq 3.5t$  the use is not mandatory, but for the safety of all road users of course possible and recommended. The flashing orange warning light function of the OSRAM LEDguardian TRUCK FLARE Signal TA19 is visible from a great distance and can provide crucial information about a dangerous situation on the road in an emergency. In addition to the warning triangle, it alerts other road users about a potentially dangerous situation on the road by actively flashing, compared to the simple reflection such as that of a warning triangle. With 6 long-life high-power LEDs with up to 6000K, you can draw attention to yourself by day and night, and preventively alert and warn other road users of a dangerous situation, such as a broken-down vehicle on the road. In addition, the TRUCK FLARE can also serve as a torchlight. As an additional function, a bright white torchlight is integrated and enables additional applications such as a work or inspection light. The compact design allows you to store the warning light within easy reach in the vehicle and, if required, it can be set up quickly and easily directly next to the warning triangle thanks to the fold-out, robust and non-slip feet. Another advantage is that the batteries included in the scope of delivery mean that the OSRAM LEDguardian TRUCK FLARE Signal TA19 is immediately ready for operation. The LEDguardian TRUCK FLARE Signal TA19 has been tested and validated in our DIN EN ISO/IEC 17025 certified environmental simulation laboratory for extreme external influences in terms of water, dust, heat, cold and impacts from falls. With an IP54 protection class, the OSRAM LEDguardian TRUCK FLARE Signal TA19 is resistant to the ingress of water and dust. OSRAM provides a 2-year guarantee\* on this product.

# Product datasheet

## Technical data

### Product information

Order reference	LEDSL103
Application (Category and Product specific)	Warning and safety lights

### Electrical data

Nominal wattage	1.50/3.0 W
Nominal voltage	6.0 V

### Photometrical data

Color temperature	2000/6000 K
Light color LED	Orange / White

### Dimensions & weight

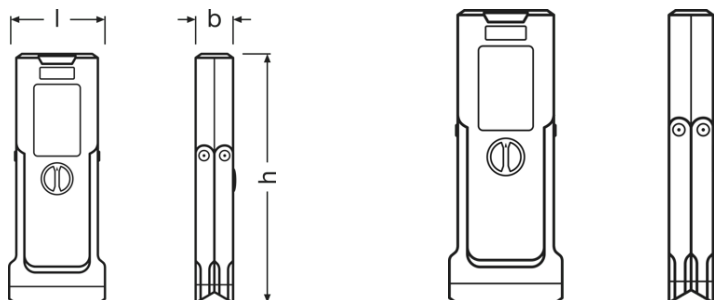

Product weight	600.00 g
Length	90.0 mm
Width	43.0 mm
Height	236.0 mm

### Lifespan

Guarantee	2 years
-----------	---------

### Additional product data

Type of Battery	Alkaline
Scope of battery	Yes
Battery	4X LR6

### Capabilities

## Product datasheet

Technology	LED
------------	-----

### Certificates & standards

Standards	CE
Type of protection	IP54

### Country specific categorizations

Order reference	LEDSL103
-----------------	----------

### Environmental information





Information according Art. 33 of EU Regulation (EC) 1907/2006 (REACH)	
Date of Declaration	19-02-2024
Primary Article Identifier	4062172185967   4062172185943   4062172185929
Declaration No. in SCIP database	In work

### Logistical Data

Product code	Product description	Packaging unit (Pieces/Unit)	Dimensions (length x width x height)	Volume	Gross weight
4062172185967	LEDguardian TA19	Folding carton box 1	100 mm x 50 mm x 255 mm	1.28 dm <sup>3</sup>	653.00 g
4062172185974	LEDguardian TA19	Shipping carton box 10	255 mm x 210 mm x 290 mm	15.53 dm <sup>3</sup>	6880.00 g



The mentioned product code describes the smallest quantity unit which can be ordered. One shipping unit can contain one or more single products. When placing an order, for the quantity please enter single or multiples of a shipping unit.

### Download Data

File
 User instruction LEDguardian TRUCK FLARE Signal TA19
 Brochures OSRAM LEDguardian Truckflare TA19 Flyer (EN)
 Movie application Product Video OSRAM LEDguardian TRUCK FLARE Signal TA19 (EN)
 Movie application Product Video OSRAM LEDguardian TRUCK FLARE Signal TA19 (EN)
 Movie application LEDguardian ROAD FLARE Signal TA19 Social Media Reel (EN)

## Product datasheet

---

	Movie application LEDguardian ROAD FLARE Signal TA19 Social Media Reel Camper (EN)
	Video OSRAM LEDguardian TRUCK FLARE Signal TA19 - Camper
	360 Degree Image OSRAM LEDguardian Truckflare TA19

---

### Legal advice

\*for precise conditions please refer to:

[www.osram.com/am-guarantee](http://www.osram.com/am-guarantee)

Application advice:

For more detailed application information and graphics please see product datasheet and user manual.

### Application advice

For more detailed application information and graphics please see product datasheet.

### Disclaimer

Subject to change without notice. Errors and omission excepted. Always make sure to use the most recent release.

# OSRAM